

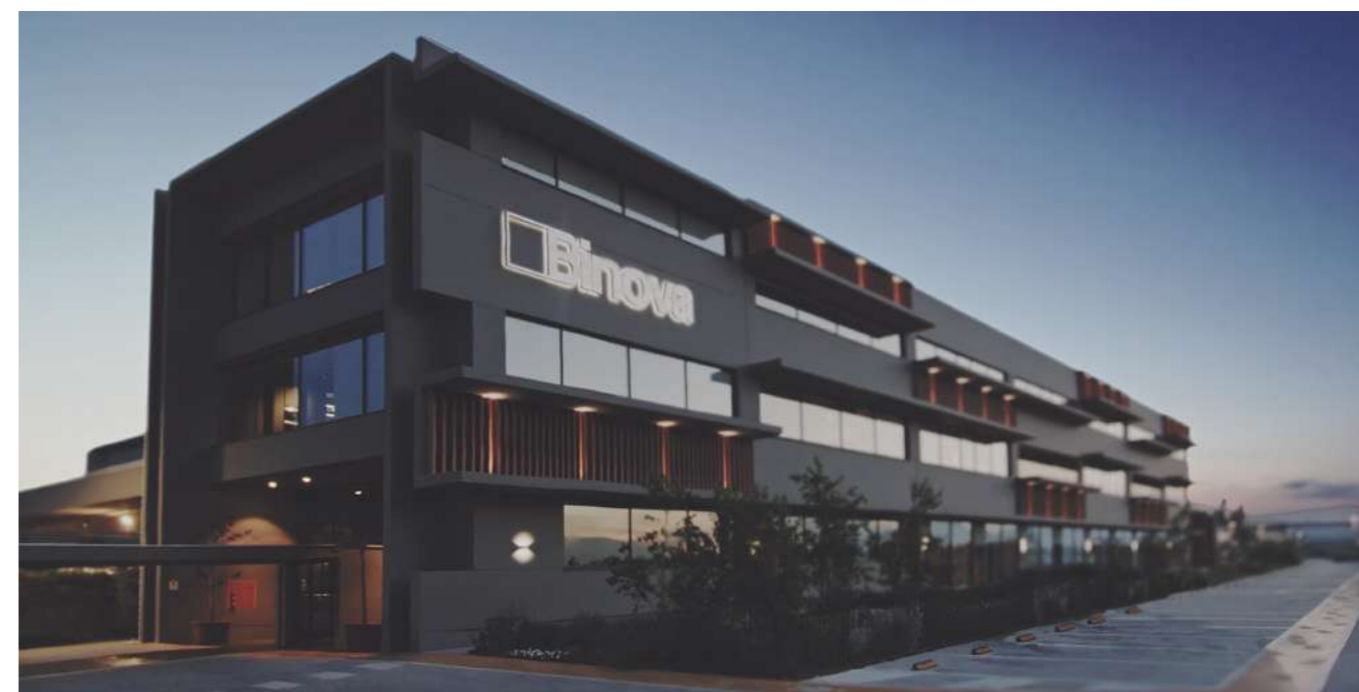

## STORIA HISTORY

Binova è un'azienda che da oltre 60 anni rappresenta un'eccellenza nel mercato delle cucine di alta gamma. Nel corso della sua lunga storia, il marchio ottiene innumerevoli premi internazionali. Tali riconoscimenti valorizzano la naturale attitudine del brand a proiettarsi sempre in avanti, attraverso brevetti che rivoluzionano convinzioni radicate e mediante invenzioni che anticipano i trend e semplificano notevolmente l'abitare. Binova nasce nel 1958 all'interno del laboratorio di Giovanni e Francesco Bolletta, due giovanissimi falegnami di Petrignano d'Assisi, che integrano il saper fare artigianale con innovazioni tecnologiche provenienti dal mondo automobilistico americano. Ben presto, da semplice bottega l'azienda si trasforma in una realtà industriale che contribuisce a scrivere la storia del design mondiale. Le collezioni Binova, nate da una ricerca progettuale continua, sono caratterizzate da prodotti assolutamente innovativi e rivoluzionari che si distinguono per una straordinaria attenzione ai dettagli e una cura unica e impareggiabile per la qualità. Nel 2016 Inizia un nuovo capitolo della storia di Binova con il passaggio al gruppo Cubo Design, affermata realtà abruzzese guidata da Antonio Arangiario. L'industriale vanta una consolidata esperienza nel settore delle cucine componibili che gli ha permesso di imporsi come protagonista assoluto nel comparto legno-arredo. Dotato di una lungimirante cultura imprenditoriale e di una innata sensibilità nel percepire le esigenze del mercato e prevedere i mutamenti dello stile, dà al marchio nuova linfa e una forte identità. Consistenti investimenti si affiancano a un'incessante attività di ricerca e sviluppo, mantenendo sempre intatti sia il know-how tecnologico, sia il carattere ricercato e il design tipicamente italiano dal sapore contemporaneo che hanno decretato il successo del brand. Grazie all'attuale corso aziendale, forme e materiali innovativi entrano a far parte dell'heritage Binova e nascono collezioni in grado di soddisfare i più alti standard estetici. Nel 2017, Binova continua la propria crescita inarrestabile con l'apertura del primo flagship store nel distretto del design milanese con una superficie espositiva di ben 350 m2. Il 2019 è invece l'anno della trasformazione a livello produttivo, dal momento che viene inaugurato Factory-One, avanguardistico stabilimento del marchio in cui si lavora ogni componente a partire da zero, garantendo massimo controllo qualitativo e possibilità di personalizzazione dei prodotti illimitate. Nel 2021 avviene il lancio dell'attesissimo sistema casa, un progetto integrato caratterizzato da collezioni non più destinate unicamente all'arredamento dell'ambiente cucina ma che, in un continuum di finiture, abbracciano la zona giorno, giungendo a contaminare persino strutture architettoniche portanti come i pilastri, per una casa in total look Binova che rappresenta il segno dell'ascesa continua del marchio.

Binova is a company that has represented excellence in the high-end kitchen market for over 60 years. Throughout its long history, the brand has won countless international awards. These awards enhance the brand's natural attitude to always project itself forward, through patents that revolutionize deep-rooted convictions and through inventions that anticipate trends and greatly simplify living. Binova was born in 1958 in the laboratory of Giovanni and Francesco Bolletta, two very young carpenters from Petrignano d'Assisi, who integrate craftsmanship with technological innovations from the American automotive world. Soon, from a simple workshop, the company turns into an industrial reality that contributes to writing the history of world design. The Binova collections, born from a continuous design research, are characterized by absolutely innovative and revolutionary products that are distinguished by an extraordinary attention to detail and a unique and unparalleled attention to quality. 2016 A new chapter in the history of Binova begins with the passage to the Cubo Design group, an established Abruzzo company led by Antonio Arangiario. The industrialist boasts a consolidated experience in the modular kitchen sector that has allowed him to establish himself as the absolute protagonist in the wood-furniture sector. Equipped with a far-sighted entrepreneurial culture and an innate sensitivity in perceiving the needs of the market and foreseeing changes in style, he gives the brand new life and a strong identity. Substantial investments go hand in hand with incessant research and development, always keeping intact both the technological know-how and the refined character and typically Italian design with a contemporary flavor that have made the brand successful. Thanks to the current company course, innovative shapes and materials become part of the Binova heritage and collections able to meet the highest aesthetic standards are born. In 2017, Binova continues its unstoppable growth with the opening of the first flagship store in the Milanese design district with an exhibition area of 350 m2. 2019, on the other hand, is the year of transformation at the production level, since Factory-One is inaugurated, the brand's avant-garde factory in which each component is processed starting from scratch, guaranteeing maximum quality control and unlimited product customization possibilities. In 2021 the highly anticipated home system is launched, an integrated project characterized by collections no longer intended solely for furnishing the kitchen environment but which, in a continuum of finishes, embrace the living area, even contaminating load-bearing architectural structures such as the pillars, for a house in a Binova total look that represents the sign of the continuous rise of the brand.



## INNOVAZIONE 4.0 INNOVATION 4.0

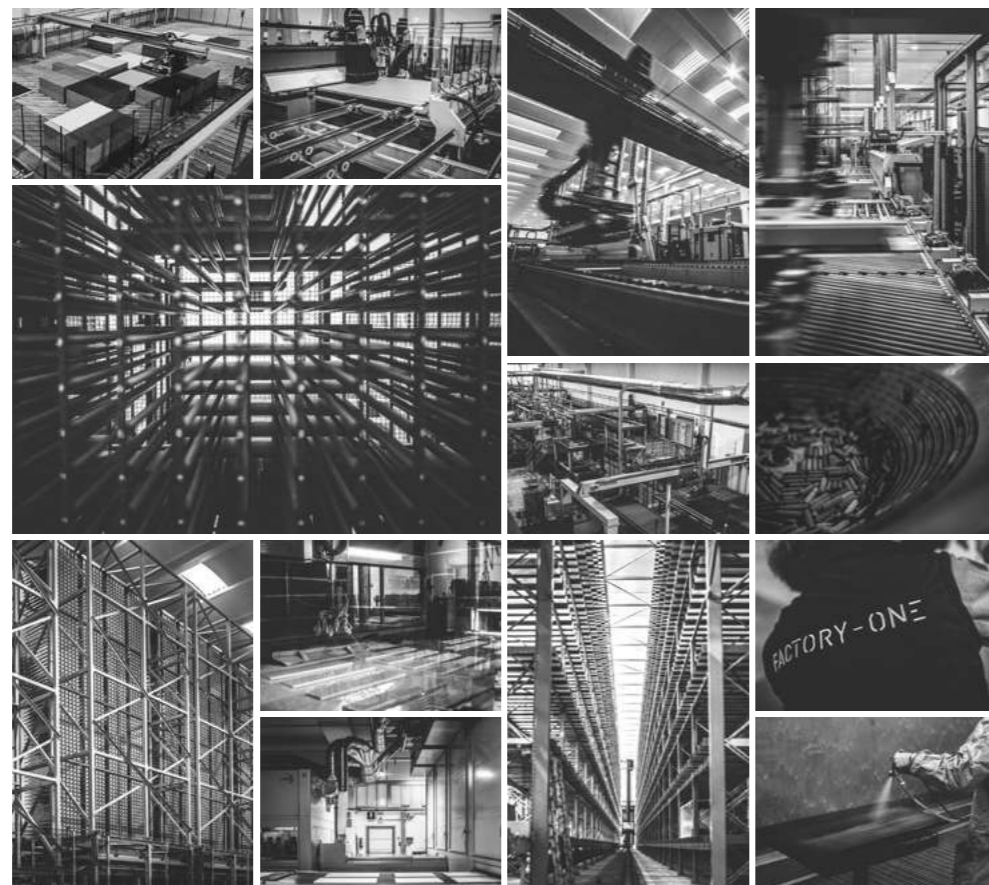

Il 2018 ha il sapore di un vero e proprio passo epocale per Cubo Design. Viene attuata una riorganizzazione radicale dei suoi asset principali, attraverso un'interpretazione del futuro ispirata ad efficienza, efficacia e rispetto dell'ambiente, che nel nuovo polo di 25.000 m<sup>2</sup> trovano concretezza grazie a soluzioni tecniche, informatiche ed energetiche, totalmente integrate: nasce Factory-One. Una struttura avveniristica, in cui la produzione di cucine viene affrontata e risolta con sistemi intelligenti, attraverso l'integrazione totale tra processi e controllo umano. Un percorso con andamento lineare e non più ad isole di lavoro, costituito da macchinari altamente tecnologici, interconnessi e contraddistinti da assoluta precisione, costantemente garantita mediante il controllo effettuato da manodopera specializzata. Appositi sensori che sfruttano il collegamento alla rete, permettono di monitorare le varie fasi della lavorazione industriale e di conoscere in tempo reale lo status delle apparecchiature su cui sono collegati. Un sistema d'eccellenza, in cui il concetto di industry 4.0 viene implementato in modo completo, divenendo propulsore del business di Cubo Design.

2018 has the flavor of a real epochal step for Cubo Design. A radical reorganization of its main assets is implemented, through an interpretation of the future inspired by efficiency, effectiveness and respect for the environment, which in the new pole of 25.000 m<sup>2</sup> are concretized thanks to fully integrated technical, IT and energy solutions: Factory-One is born. A futuristic structure, in which the production of kitchens is addressed and resolved with intelligent systems, through the total integration between processes and human control. A route with a linear progress and no longer with work islands, made up of highly technological machinery, interconnected and characterized by absolute precision, constantly guaranteed through the control carried out by skilled labor. Special sensors that exploit the connection to the network, allow you to monitor the various stages of industrial processing and to know in real time the status of the equipment on which they are connected. A system of excellence, in which the concept of industry 4.0 is fully implemented, becoming the driving force behind Cubo Design's business.

COLLEZIONI COLLECTIONS



08  
25

AVOLA LEGNO



26  
43

BLUNA LACCATO LUCIDO



44  
57

MANTIS + LAB



58  
69

REGULA + BLUNA



BLUNA METAL 4.0

70  
83



84  
95

AVOLA GRES



MANTIS + BLUNA

96  
109



110  
121

REFLEX + VOGUE



BLUNA LEGNO

122  
133



BLUNA TECH BRUNITO

146  
157



BLUNA TECH CHAMPAGNE

158  
169

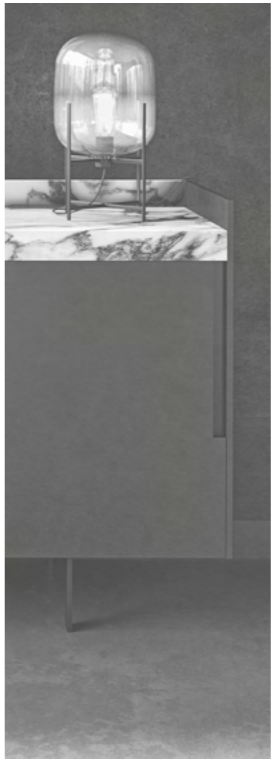

134  
145

VOGUE + BLUNA

8

9

**AVOLA** LEGNO



## AVOLA LEGNO

11

Un progetto che si pone l'obiettivo di dare libertà totale ai materiali, di poter coesistere e di essere raccolti in un unico insieme determinato dal telaio in alluminio Avola in grado di abbracciare il legno, il vetro ed il gres nello stesso momento. Lo spazio si delinea partendo da una prospettiva centrale che sviluppa due grandi pareti, ciascuna con differenti funzioni. A destra una parete living caratterizzata da volumi a sbalzo che si intersecano tra loro, le basi a terra fungono da contenitori e appoggio per la tv, un piano sospeso in legno utile come spazio di lavoro temporaneo, boiserie con mensole illuminate e colonne dall'ampio contenimento alleggerite dal sistema L +1.5. A sinistra una madia Avola con ante riflettenti per una completa integrazione nello spazio ed una parete con ante retrattili attrezzata per consentire uno spazio home working ottimale. Al centro si sviluppa la zona conviviale con tavolo, divano e coffee table. A project that aims to give total freedom to materials, to be able to coexist and be collected in a single whole determined by the Avola aluminum frame capable of embracing wood, glass and gres at the same time. The space is outlined starting from a central perspective that develops two large walls, each with different functions. On the right, a living wall characterized by cantilevered volumes that intersect each other, the lower bases allow storage and support for the TV, a suspended wooden top useful as a temporary work space, boiserie with illuminated shelves and columns with shelves lightened by the L +1.5 system. On the left, an Avola sideboard with reflective doors for complete integration into the space and a wall with retractable doors equipped to allow an optimal home working space. At the center is the convivial area with table, sofa and coffee table.





14

15



**DETTAGLIO TAVOLO  
MOOR 02, BASAMENTO  
IN LEGNO FRASSINO  
CARBONE E PIANO  
IN GRES VERDE  
BORGOGNA LUCIDO.**

**DETAIL OF MOOR 02  
TABLE, BASE IN WOOD  
FRASSINO CARBONE  
FINISH AND TOP IN  
GRES VERDE BORGOGNA  
GLOSSY FINISH.**

**DETAIL OF MOOR 02  
TABLE, BASE IN WOOD  
FRASSINO CARBONE  
FINISH AND TOP IN  
GRES VERDE BORGOGNA  
GLOSSY FINISH.**

**DETAIL OF MOOR 02  
TABLE, BASE IN WOOD  
FRASSINO CARBONE  
FINISH AND TOP IN  
GRES VERDE BORGOGNA  
GLOSSY FINISH.**







18

19

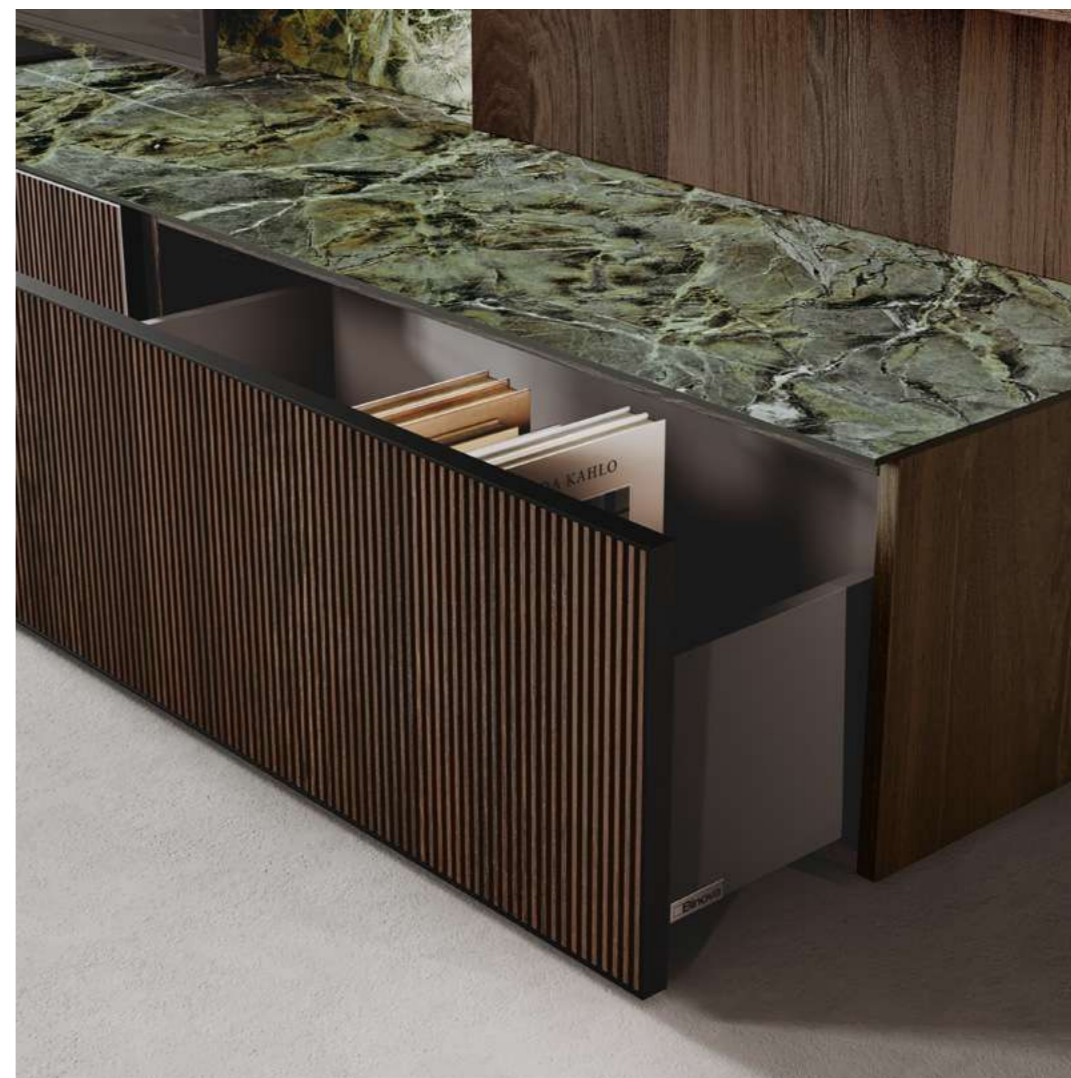

DETTAGLIO PARETE  
LIVING, BASI BASSE  
AVOLA LEGNO ROVERE  
TERMOTRATTATO E  
TELAIO NERO, TOP GRES  
VERDE BORGOGNA  
LUCIDO, BOISERIE  
LEGGNO ROVERE  
TERMOTRATTATO,  
COLONNE BLUNA  
LACCATO METAL 4.0  
FINITURA PELTRO.

LIVING WALL DETAIL,  
LOWER BASES AVOLA  
WOOD ROVERE  
TERMOTRATTATO FINISH  
AND BLACK FRAME,  
TOP GRES VERDE  
BORGOGNA GLOSSY  
FINISH, BOISERIE WOOD  
ROVERE TERMOTRATTATO  
FINISH, BLUNA COLUMNS  
LACQUERED METAL 4.0  
PELTRO FINISH.

LIVING WALL DETAIL,  
LOWER BASES AVOLA  
WOOD ROVERE  
TERMOTRATTATO FINISH  
AND BLACK FRAME,  
TOP GRES VERDE  
BORGOGNA GLOSSY  
FINISH, BOISERIE WOOD  
ROVERE TERMOTRATTATO  
FINISH, BLUNA COLUMNS  
LACQUERED METAL 4.0  
PELTRO FINISH.

LIVING WALL DETAIL,  
LOWER BASES AVOLA  
WOOD ROVERE  
TERMOTRATTATO FINISH  
AND BLACK FRAME,  
TOP GRES VERDE  
BORGOGNA GLOSSY  
FINISH, BOISERIE WOOD  
ROVERE TERMOTRATTATO  
FINISH, BLUNA COLUMNS  
LACQUERED METAL 4.0  
PELTRO FINISH.



DETTAGLIO  
COLONNE HOME  
WORKING CON ANTE  
RIENTRANTI BLUNA  
LACCATO METAL 4.0  
PELTRO. BOISERIE  
LEGNO ROVERE  
TERMOTRATTATO.

DETAIL OF HOME  
WORKING COLUMNS  
WITH RETRACTABLE  
DOORS BLUNA  
LACQUERED METAL  
4.0 PELTRO FINISH.  
BOISERIE WOOD ROVERE  
TERMOTRATTATO FINISH.

DETAIL OF HOME  
WORKING COLUMNS  
WITH RETRACTABLE  
DOORS BLUNA  
LACQUERED METAL  
4.0 PELTRO FINISH.  
BOISERIE WOOD ROVERE  
TERMOTRATTATO FINISH.

DETAIL OF HOME  
WORKING COLUMNS  
WITH RETRACTABLE  
DOORS BLUNA  
LACQUERED METAL  
4.0 PELTRO FINISH.  
BOISERIE WOOD ROVERE  
TERMOTRATTATO FINISH.

DETTAGLIO MADIA  
AVOLA CON TELAIO  
NERO OPACO E VETRO  
STOPSOL FUME'.  
BASAMENTO ROUND  
IN METALLO FINITURA  
NERO OPACO.

DETAIL OF AVOLA  
SIDEBOARD WITH  
MATT BLACK FRAME  
AND STOPSOL FUME'  
GLASS. ROUND LOWER  
STRUCTURE METAL  
MATT BLACK FINISH.

DETAIL OF AVOLA  
SIDEBOARD WITH  
MATT BLACK FRAME  
AND STOPSOL FUME'  
GLASS. ROUND LOWER  
STRUCTURE METAL  
MATT BLACK FINISH.

DETAIL OF AVOLA  
SIDEBOARD WITH  
MATT BLACK FRAME  
AND STOPSOL FUME'  
GLASS. ROUND LOWER  
STRUCTURE METAL  
MATT BLACK FINISH.



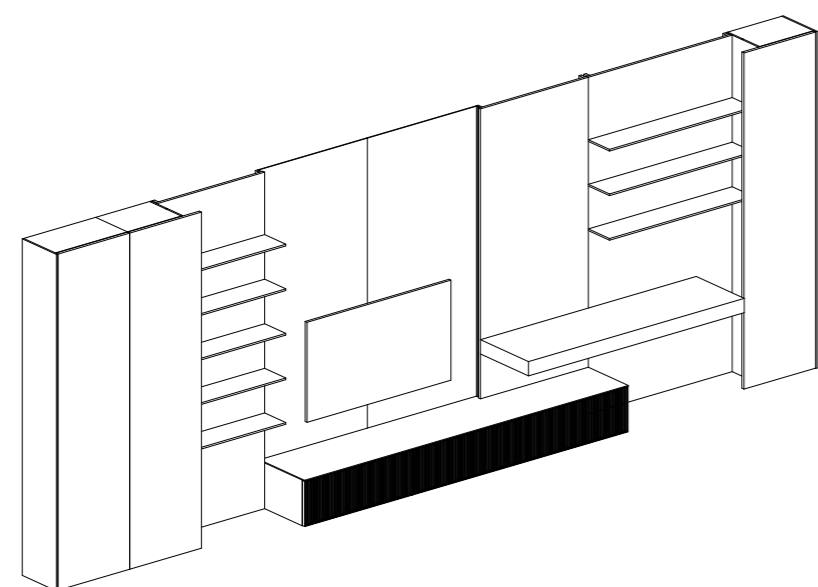

**PARETE LIVING LIVING WALL**

L 635 H 235,5 P 47,5

BLUNA LACCATO METAL 4.0 PELTRO  
 AVOLA LEGNO RIGATO ROVERE TERMOTRATTATO  
 CON TELAIO NERO OPACO  
 SCHIENALE GRES VERDE BORGOGNA LUCIDO

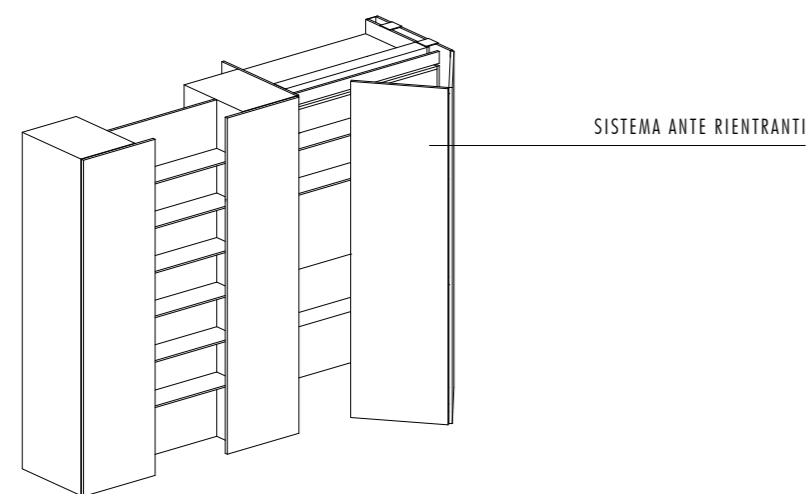

**PARETE STUDIO HOME WORKING WALL**

L 310 CM H 235,5 P 80

BLUNA LACCATO METAL 4.0 PELTRO  
 AVOLA LEGNO RIGATO ROVERE TERMOTRATTATO  
 CON TELAIO NERO OPACO

**AVOLA LEGNO**

**SCHEDA TECNICA DATA SHEET  
 FICHE TECHNIQUE FICHA DE DATOS**

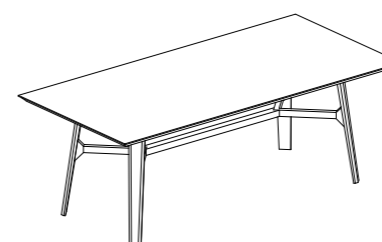

**TAVOLO MOOR 02 TABLE**

L. 200 H. 76 P. 100

TOP GRES VERDE BORGOGNA LUCIDO  
 STRUTTURA LEGNO FRASSINO CARBONE E  
 SOTTOPIANA LACCATO OPACO NERO TRAFFICO

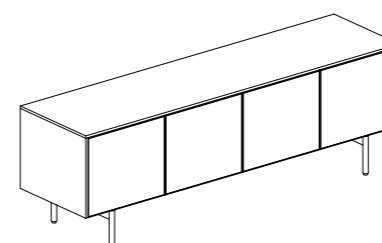

**MADIA SIDEBOARD**

L. 183 H. 62,2 P. 47,5

AVOLA VETRO STOPSOL SPECCHIO FUMÈ CON TELAIO NERO  
 STRUTTURA INTERNA LACCATO OPACO ROSSO TOSCA  
 TOP E FIANCHI LEGNO ROVERE TERMOTRATTATO  
 BASAMENTO ROUND METALLO NERO OPACO

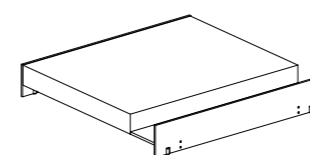

**TAVOLO DA CAFFÈ COFFEE TABLE**

L. 100 H. 16 P. 100

TOP ALTO LEGNO ROVERE TERMOTRATTATO  
 TOP SOTTILE GRES VERDE BORGOGNA LUCIDO  
 STRUTTURA METALLO NERO OPACO

26

27

**BLUNA** LACCATO LUCIDO



## BLUNA LACCATO LUCIDO

29

La trasversalità del modello Bluna è espressa in questo ambiente mediante una sapiente miscela di materiali riflettenti e superfici materiche per un connubio unico. Gli arredi di questo spazio si sviluppano attorno ad una parete di forma sinusoidale e determinato uno spazio vivibile a 360°. Nella prima area si sviluppa un angolo living costituito a destra da vetrine con funzione bar per poi proseguire con basi basse in laccato lucido con sistema zenit e boiserie leaf con mensole sfalsate. La parete prosegue con colonne che si ricordano ad una zona cucina con ante retrattili di modo da confondersi in uno spazio lineare e fluido. A completare lo spazio intervengono la madia ed in coffe table sempre nelle stesse finiture. The transversality of the Bluna model is expressed in this environment by a wise mixture of reflective materials and material surfaces for a unique connubio. The furnishings of this space develop around a sinusoidal wall and determined a livable 360° space. In the first area there is a living angle consisting of the right from showcases with bar function and then continue with low bases in glossy lacquered with zenit system and leaf boiserie with staggered shelves. The wall continues with columns that are linked to a kitchen area with retractable doors so as to be confused in a linear and fluid space. To complete the space spoke the sideboard and in coffe table always in the same finishes.







32

33



DETTAGLIO COLONNA  
BAR CON ANTE MILES  
IN VETRO FUME' E  
TELAIO IN FINITURA  
ALLUMINIO NERO.  
BASI BASSE FINITURA  
LACCATO LUCIDO  
CARRUBA, PIANO  
E SCHIENALE GRES  
FINITURA OROBICO  
DARK LUCIDO.

DETAIL OF BAR  
COLUMN WITH MILES  
DOORS MADE IN  
FUME' GLASS AND  
BLACK ALUMINUM  
FRAME. LOWER  
UNIT IN GLOSSY  
LACQUERED CARRUBA  
FINIS, TOP AND  
BACK PANEL IN GRES  
OROBICO DARK FINISH.

DETAIL OF BAR  
COLUMN WITH MILES  
DOORS MADE IN  
FUME' GLASS AND  
BLACK ALUMINUM  
FRAME. LOWER  
UNIT IN GLOSSY  
LACQUERED CARRUBA  
FINIS, TOP AND  
BACK PANEL IN GRES  
OROBICO DARK FINISH.

DETAIL OF BAR  
COLUMN WITH MILES  
DOORS MADE IN  
FUME' GLASS AND  
BLACK ALUMINUM  
FRAME. LOWER  
UNIT IN GLOSSY  
LACQUERED CARRUBA  
FINIS, TOP AND  
BACK PANEL IN GRES  
OROBICO DARK FINISH.





DETTAGLIO ZONA  
CUCINA CON  
ANTE RETRATTILI  
IN FINITURA  
BILAMINATO LEGNO  
ROVERE QUERCIA.  
TAVOLO MOOR 04  
CON STRUTTURA IN  
FRASSINO CARBONE  
E PIANO IN GRES  
OROBICO DARK LUCIDO.

DETAIL OF KITCHEN  
AREA WITH  
RETRACTABLE DOORS  
IN BILAMINATE  
ROVERE QUERCIA  
FINISH. MOOR  
04 TABLE WITH  
STRUCTURE FRASSINO  
CARBONE FINISH AND  
TOP IN GRES OROBICO  
DARK FINISH.

DETAIL OF KITCHEN  
AREA WITH  
RETRACTABLE DOORS  
IN BILAMINATE  
ROVERE QUERCIA  
FINISH. MOOR  
04 TABLE WITH  
STRUCTURE FRASSINO  
CARBONE FINISH AND  
TOP IN GRES OROBICO  
DARK FINISH.

DETAIL OF KITCHEN  
AREA WITH  
RETRACTABLE DOORS  
IN BILAMINATE  
ROVERE QUERCIA  
FINISH. MOOR  
04 TABLE WITH  
STRUCTURE FRASSINO  
CARBONE FINISH AND  
TOP IN GRES OROBICO  
DARK FINISH.



DETTAGLIO ZONA  
CUCINA CON ANTE  
RETRATTILI IN  
FINITURA BILAMINATO  
LEGNO ROVERE  
QUERCIA. MODULI  
INTERNI TECH  
FINITURA ALLUMINIO  
BRUNITO CON GOLA  
EMME NERO OPACO E  
TOP IN GRES FINITURA  
OROBICO DARK.

DETAIL OF KITCHEN  
AREA WITH  
RETRACTABLE DOORS  
IN BILAMINATE ROVERE  
QUERCIA FINISH.  
INTERNAL MODULES  
IN TECH ALLUMINIO  
BRUNITO FINISH WITH  
EMME GROOVE MATT  
BLACK FINISH AND  
TOP IN GRES OROBICO  
DARK FINISH.

DETAIL OF KITCHEN  
AREA WITH  
RETRACTABLE DOORS  
IN BILAMINATE ROVERE  
QUERCIA FINISH.  
INTERNAL MODULES  
IN TECH ALLUMINIO  
BRUNITO FINISH WITH  
EMME GROOVE MATT  
BLACK FINISH AND  
TOP IN GRES OROBICO  
DARK FINISH.

DETAIL OF KITCHEN  
AREA WITH  
RETRACTABLE DOORS  
IN BILAMINATE ROVERE  
QUERCIA FINISH.  
INTERNAL MODULES  
IN TECH ALLUMINIO  
BRUNITO FINISH WITH  
EMME GROOVE MATT  
BLACK FINISH AND  
TOP IN GRES OROBICO  
DARK FINISH.





40

41



DETTAGLIO MADIA  
IN LACCATO LUCIDO  
CARRUBA. TOP GRES  
OROBICO DARK  
LUCIDO. BASAMENTO  
CUT BRONZO OPACO.  
STRUTTURA INTERNA  
LACCATO OPACO  
FINITURA BLU OCEANO.

DETAIL OF SIDEBOARD  
GLOSSY LACQUERED  
CARRUBA FINISH. TOP  
IN GRES OROBICO  
DARK FINISH. CUT  
BASE BRONZE FINISH.  
INTERNAL STRUCTURE  
MATT LACQUERED BLU  
OCEANO FINISH.

DETAIL OF SIDEBOARD  
GLOSSY LACQUERED  
CARRUBA FINISH. TOP  
IN GRES OROBICO  
DARK FINISH. CUT  
BASE BRONZE FINISH.  
INTERNAL STRUCTURE  
MATT LACQUERED BLU  
OCEANO FINISH.

DETAIL OF SIDEBOARD  
GLOSSY LACQUERED  
CARRUBA FINISH. TOP  
IN GRES OROBICO  
DARK FINISH. CUT  
BASE BRONZE FINISH.  
INTERNAL STRUCTURE  
MATT LACQUERED BLU  
OCEANO FINISH.

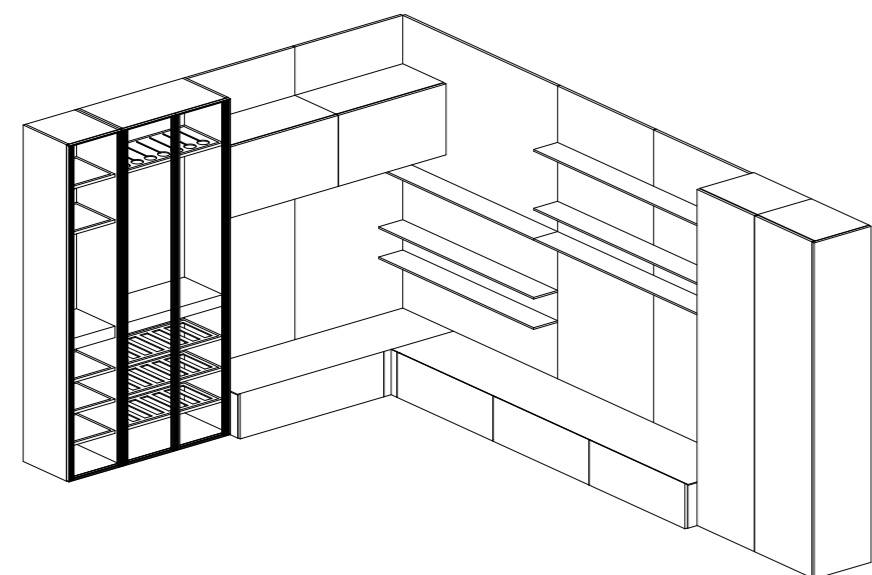
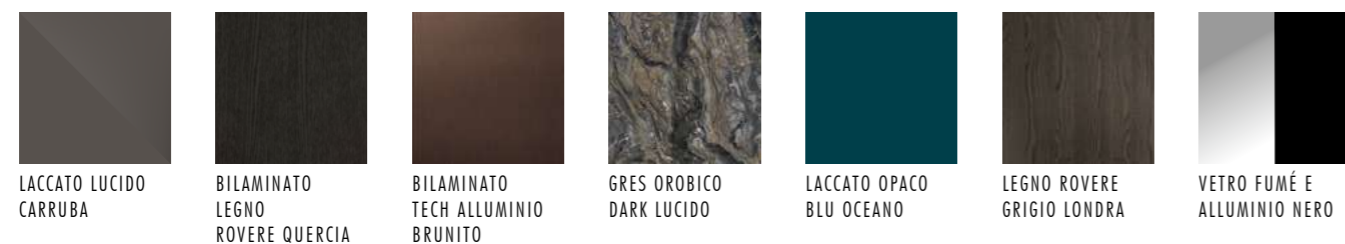

**PARETE LIVING LIVING WALL**

L 486X319 H 235,5 P 47,5/55

BLUNA 30° LACCATO LUCIDO CARRUBA  
 BLUNA BILAMINATO LEGNO ROVERE QUERCIA  
 VETRINE REFLEX TELAIO NERO E VETRO FUMÉ,  
 STRUTTURA BILAMINATO LEGNO ROVERE QUERCIA  
 SCHIENALE GRES OROBICO DARK LUCIDO E TECH ALLUMINIO BRUNITO

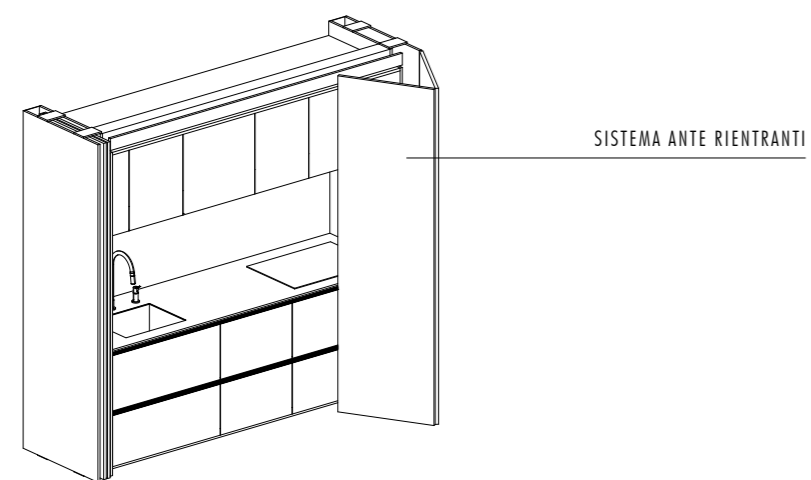

**PARETE CUCINA KITCHEN WALL**

L 270 CM H 235,5 P 80

BLUNA BILAMINATO LEGNO ROVERE QUERCIA  
 BLUNA TECH ALLUMINIO BRUNITO  
 TOP GRES OROBICO DARK LUCIDO

**BLUNA LACCATO LUCIDO**

**SCHEDA TECNICA DATA SHEET  
 FICHE TECHNIQUE FICHA DE DATOS**



**TAVOLO MOOR 01 TABLE**

L. 150 H. 76 P. 150

TOP GRES OROBICO DARK LUCIDO  
 STRUTTURA LEGNO FRASSINO CARBONE E  
 SOTTOPIANA LACCATO OPACO NERO TRAFFICO

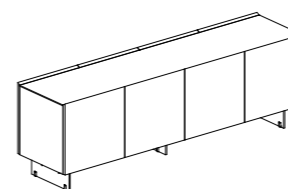

**MADIA SIDEBOARD**

L. 200 H. 66 P. 50

BLUNA 30° LACCATO LUCIDO CARRUBA  
 STRUTTURA INTERNA LACCATO OPACO BLU OCEANO  
 TOP GRES OROBICO DARK LUCIDO  
 BASAMENTO CUT METALLO BRONZO

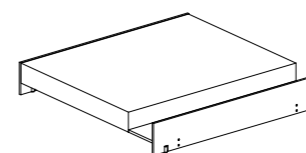

**TAVOLO DA CAFFÈ COFFEE TABLE**

L. 100 H. 16 P. 100

TOP ALTO LEGNO ROVERE GRIGIO LONDRA  
 TOP SOTTILE GRES OROBICO DARK LUCIDO  
 STRUTTURA METALLO NERO OPACO

44

45

**MANTIS** + LAB



## MANTIS + LAB

47

Un ambiente che celebra la tecnologia dei materiali, da un lato Mantis con ante spessore 12 mm in legno spina di pesce e cuore in alveolare di alluminio per estendere i frontali oltre i limiti ordinari mentre dall'altro Lab con ante in telaio di alluminio capaci di sostenere lastre di gres nella parte frontale. La parete living è connotata da 3 elementi fondamentali, a sinistra le colonne alte interrotte dalle vetrine reflex, a destra una linea sottilissima rappresentata dalle basi in gres ed i moduli folding, mentre in alto i pensili in alluminio riflettente in total look con i riflessi del gres finitura pietra. A seguire si snoda la zona pranzo con tavolo e due madie alte ad uso bar. La continuità degli ambienti diventa logica, mentre l'espressione della tecnologia arriva persino ad alleggerire il metallo, rendendo l'insieme degli elementi più raffinato e al contempo più forte e persistente. An environment that celebrates the technology of the materials, on one side Mantis with 12 mm thick door in wood plug and heart in aluminum alveolar to extend the fronts beyond the ordinary limits while on the other lab with doors in aluminum frame capable of Support stoneware plates in the front. The Living wall is connoted by 3 fundamental elements, on the left the high columns interrupted by the SLR showcases, to the right a very thin line represented by the bases in stoneware and folding modules, while in high the reflective aluminum wall units in total look with the reflections of the Stone finish stoneware. Following is the dining area with table and two high machines for bar use. The continuity of the rooms becomes logical, while the expression of technology even comes to lighten the metal, making the whole elements more refined and at the same time stronger and persistent.







50

51



DETTAGLIO PARETE  
LIVING IN LAB GRES  
FINITURA GRIS DU  
GENT OPACO E TELAIO  
CHAMPAGNE, MODULI  
FOLDING E PENSILI  
TECH ALLUMINIO  
CHAMPAGNE,  
COLONNE MANTIS  
LEGNO SPINA DI  
PESCE ROVERE MAGMA  
E VETRINE REFLEX  
TELAIO CHAMPAGNE E  
VETRO FUMÉ.

LIVING WALL DETAIL  
IN LAB GRES GRIS DU  
GENT MATT FINISH AND  
CHAMPAGNE FRAME,  
FOLDING MODULES  
TECH ALUMINUM  
CHAMPAGNE,  
MANTIS COLUMNS  
HERRINGBONE  
WOOD ROVERE  
MAGMA FINISH AND  
REFLEX GLASS UNIT  
CHAMPAGNE FRAME  
AND FUMÉ GLASS.

LIVING WALL DETAIL  
IN LAB GRES GRIS DU  
GENT MATT FINISH AND  
CHAMPAGNE FRAME,  
FOLDING MODULES  
TECH ALUMINUM  
CHAMPAGNE,  
MANTIS COLUMNS  
HERRINGBONE  
WOOD ROVERE  
MAGMA FINISH AND  
REFLEX GLASS UNIT  
CHAMPAGNE FRAME  
AND FUMÉ GLASS.

LIVING WALL DETAIL  
IN LAB GRES GRIS DU  
GENT MATT FINISH AND  
CHAMPAGNE FRAME,  
FOLDING MODULES  
TECH ALUMINUM  
CHAMPAGNE,  
MANTIS COLUMNS  
HERRINGBONE  
WOOD ROVERE  
MAGMA FINISH AND  
REFLEX GLASS UNIT  
CHAMPAGNE FRAME  
AND FUMÉ GLASS.



DETTAGLIO MADIA ALTA IN LEGNO ROVERE CARBONE, TOP IN GRES FINITURA GRIS DU GENT OPACO E STRUTTURA LACCATO OPACO VERDE PASTELLO. TAVOLO AFFIORO 02 CON STRUTTURA IN FRASSINO CARBONE E PIANO IN GRES GRIS DU GENT OPACO.

DETAIL OF SIDEBOARD IN WOOD ROVERE CARBONE FINISH, TOP IN GRES GRIS DU GENT MATT FINISH AND STRUCTURE MATT LACQUERED VERDE PASTELLO FINISH. AFFIORO 02 TABLE WITH STRUCTURE FRASSINO CARBONE FINISH AND TOP IN GRES GRIS DU GENT MATT FINISH.

DETAIL OF SIDEBOARD IN WOOD ROVERE CARBONE FINISH, TOP IN GRES GRIS DU GENT MATT FINISH AND STRUCTURE MATT LACQUERED VERDE PASTELLO FINISH. AFFIORO 02 TABLE WITH STRUCTURE FRASSINO CARBONE FINISH AND TOP IN GRES GRIS DU GENT MATT FINISH.

DETAIL OF SIDEBOARD IN WOOD ROVERE CARBONE FINISH, TOP IN GRES GRIS DU GENT MATT FINISH AND STRUCTURE MATT LACQUERED VERDE PASTELLO FINISH. AFFIORO 02 TABLE WITH STRUCTURE FRASSINO CARBONE FINISH AND TOP IN GRES GRIS DU GENT MATT FINISH.



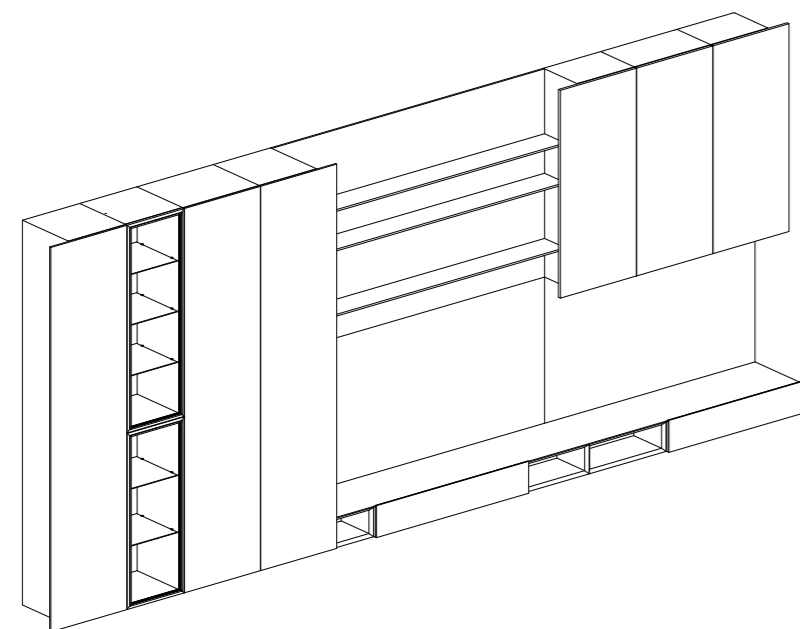
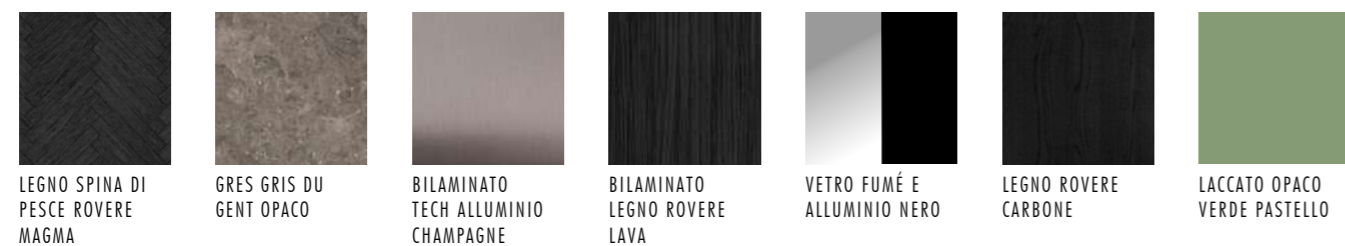

**PARETE LIVING LIVING WALL**

L 590 H 255 P 47,5

**MANTIS** LEGNO SPINA DI PESCE ROVERE MAGMA  
**LAB** GRES GRIS DU GENT OPACO CON TELAIO CHAMPAGNE  
 BLUNA TECH ALLUMINIO CHAMPAGNE  
 VETRINE REFLEX TELAIO CHAMPAGNE E VETRO FUMÉ, STRUTTURA BILAMINATO LEGNO ROVERE LAVA  
 BOISERIE LEAF E OPEN SPACE FOLDING TECH ALLUMINIO CHAMPAGNE  
 SCHIENALE GRES GRIS DU GENT OPACO

**MANTIS + LAB**

**SCHEDA TECNICA DATA SHEET**  
**FICHE TECHNIQUE FICHA DE DATOS**

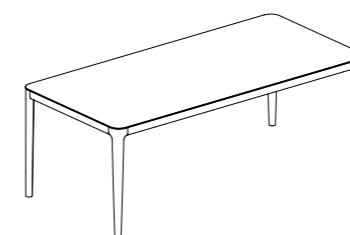

**TAVOLO FIRENZE 02 TABLE**

L. 210 H. 76 P. 100

TOP GRES GRIS DU GENT OPACO  
 STRUTTURA LEGNO FRASSINO CARBONE

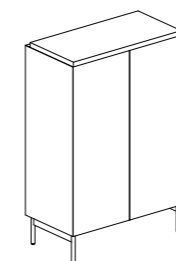

**MADIA SIDEBOARD**

L. 94,4 H. 143 P. 50

BLUNA 30° LEGNO ROVERE CARBONE  
 STRUTTURA INTERNA LACCATO OPACO VERDE PASTELLO  
 TOP GRES GRIS DU GENT OPACO  
 BASAMENTO ROUND METALLO NERO OPACO

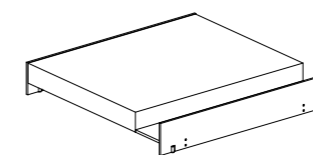

**TAVOLO DA CAFFÈ COFFEE TABLE**

L. 100 H. 16 P. 100

TOP ALTO LEGNO ROVERE CARBONE  
 TOP SOTTILE GRES GRIS DU GENT OPACO  
 STRUTTURA METALLO CHAMPAGNE

58

59

**REGULA** + BLUNA



## REGULA + BLUNA

61

Un ambiente che ruota attorno al progetto Regula, nato nell'anno 1998 e che si basa sul concetto di sospendere i mobili su piedini in alluminio. Lo spazio si snoda tra una zona pranzo con tavolo e madie alte ed una zona living costituita da una parete dove le basi basse si intersecano con una parete tv dove i giochi di luce dei pannelli di profondità diverse danno risalto alla boiserie con ripiani. Il nuovo progetto casa consente di osare sempre di più. L'audacia di cambiare può custodire il seme di quella genialità che fa intuire la direzione prima di altri, dell'attimo in cui si capisce di aver realizzato qualcosa che si credeva impossibile. An environment that revolves around the Regula project, born in the year 1998 and which is based on the concept of suspending furniture on aluminum feet. The space winds between a dining area with a table and high mothers and a living area consisting of a wall where the low bases intersect with a TV wall where the games of different depth panels emphasize the boiserie with shelves. The new home project allows you to dare more and more. The boldness of changing can guard the seed of that genius that makes the management before others, of the moment in which you understand that you have realized something that was believed impossible.







DETTAGLIO PARETE LIVING CON BASI IN FENIX ROSSO JAIPUR, PIANO IN LEGNO ROVERE CARBONE, BOISERIE IN LEGNO ROVERE CARBONE E PANNELLI SCHIENALI IN BILAMINATO MATERICO PIASENTINA.

DETAIL OF LIVING WALL WITH LOWER BASES IN ROSSO JAIPUR FENIX, TOP IN ROVERE CARBONE WOOD, BOISERIE IN ROVERE CARBONE WOOD AND BACK PANELS IN MATERICO BILAMINATE PIASENTINA.

DETAIL OF LIVING WALL WITH LOWER BASES IN ROSSO JAIPUR FENIX, TOP IN ROVERE CARBONE WOOD, BOISERIE IN ROVERE CARBONE WOOD AND BACK PANELS IN MATERICO BILAMINATE PIASENTINA.

DETAIL OF LIVING WALL WITH LOWER BASES IN ROSSO JAIPUR FENIX, TOP IN ROVERE CARBONE WOOD, BOISERIE IN ROVERE CARBONE WOOD AND BACK PANELS IN MATERICO BILAMINATE PIASENTINA.





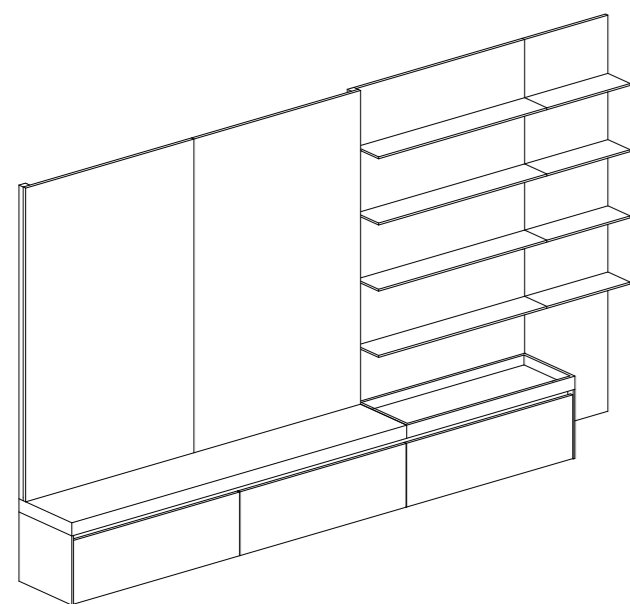
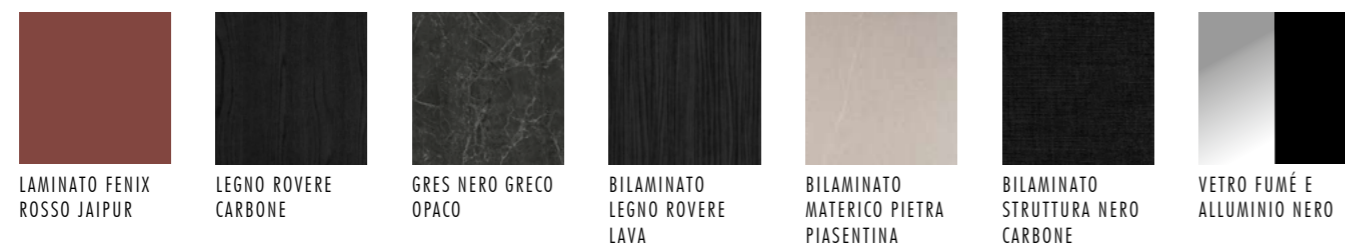

**PARETE LIVING LIVING WALL**  
 L 420 H 240 P 47,5  
 BLUNA LAMINATO FENIX ROSSO JAIPUR  
 TOP LEGNO ROVERE CARBONE CON VASCA INTEGRATA  
 BOISERIE LEAF LEGNO ROVERE CARBONE  
 SCHIENALE BILAMINATO MATERICO PIETRA PIASENTINA

REGULA + BLUNA

SCHEDA TECNICA DATA SHEET  
 FICHE TECHNIQUE FICHA DE DATOS

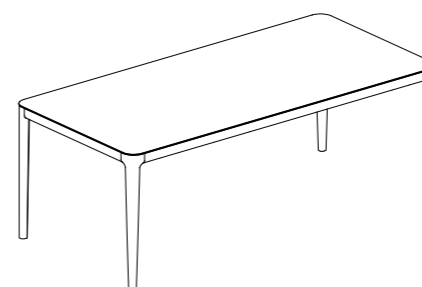

**TAVOLO FIRENZE 02 TABLE**  
 L. 210 H. 76 P. 100  
 TOP GRES NERO GRECO OPACO  
 STRUTTURA LEGNO FRASSINO CARBONE

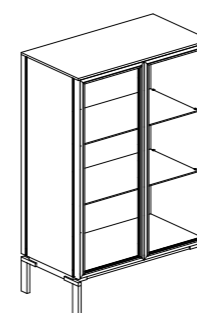

**MADIA REGULA SIDEBBOARD**  
 L. 92,4 H. 140 P. 47,5  
 VETRINE REFLEX CON TELAIO NERO E VETRO FUMÉ  
 STRUTTURA INTERNA BILAMINATO LEGNO ROVERE LAVA  
 TOP E FIANCHI LEGNO ROVERE CARBONE  
 BASAMENTO REGULA ALLUMINIO NERO OPACO

70

71

**BLUNA** METAL 4.0



## BLUNA METAL 4.0

73

Un ambiente che mette in relazione gli spazi della casa, eliminando la separazione tra zona soggiorno e cucina. Grazie all'uso delle colonne pilastri, elementi verticali contenitivi e funzionali, ogni ambiente si sviluppa in aree delimitate ma aperte, simili a spazi teatrali, di ampio respiro. Due materiali innovativi caratterizzano la composizione: da una parte, il laccato metal 4.0 che riveste le basi sospese ed esalta la modernità dell'insieme, dall'altra le vetrine illuminate sullo schienale che creano uno spettacolare effetto di rilievo. Librerie ancorate tra terra e soffitto caratterizzano l'ambiente e vanno a dividere la zona pranzo dall'ambiente circostante. An environment that connects the spaces of the house, eliminating the separation between the living area and the kitchen. Thanks to the use of pillar columns, vertical containing and functional elements, each room is developed in delimited but open areas, similar to theatrical spaces, with a broad scope. Two innovative materials characterize the composition: on the one hand, the 4.0 metal lacquer that covers the suspended bases and enhances the modernity of the whole, on the other hand the illuminated display cabinets on the back create a spectacular relief effect. Bookcases anchored between the ground and the ceiling characterize the environment and divide the dining area from the surrounding environment.





DETTAGLIO PARETE LIVING CON BASI SOSPESE IN FINITURA BLUNA LACCATO METAL 4.0 BRONZO CON PROFILO GAP IN ALLUMINIO NERO, PENSILI CON ANTE VETRO MILES CON TELAIO NERO E VETRO FUMÉ, SCHIENALI IN LEGNO FINITURA ROVERE CARBONE.

DETAIL OF LIVING WALL WITH BASE UNITS BLUNA 4.0 METAL LACQUERED BRONZE FINISH WITH BLACK ALUMINUM GAP PROFILE, WALL UNITS WITH MILES GLASS DOORS MADE IN BLACK ALUMINUM FRAME AND FUMÉ GLASS, BACK PANELS ARE IN WOOD ROVERE CARBONE FINISH.

DETAIL MUR LIVING AVEC MEUBLES BAS SUSPENDUS EN FINITION BLUNA LAQUE METAL 4.0 BRONZE AVEC PROFIL GAP EN ALUMINIUM NOIR, MEUBLES HAUTS AVEC FAÇADES EN VERRE MILES AVEC CADRE NOIR ET VERRE FUMÉ, DOS EN BOIS FINITION ROVERE CARBONE.

DETALLE PARED LIVING CON BAJOS SUSPENDIDOS LACADO METAL 4.0 ACABADO BRONZO CON PERFIL GAP EN ALUMINIO NEGRO, ALTOS CON PUERTAS DE VIDRIO MILES CON MARCO DE ALUMINIO NEGRO Y VIDRIO FUMÉ, ESPALDA EN MADERA ACABADO ROVERE CARBONE.

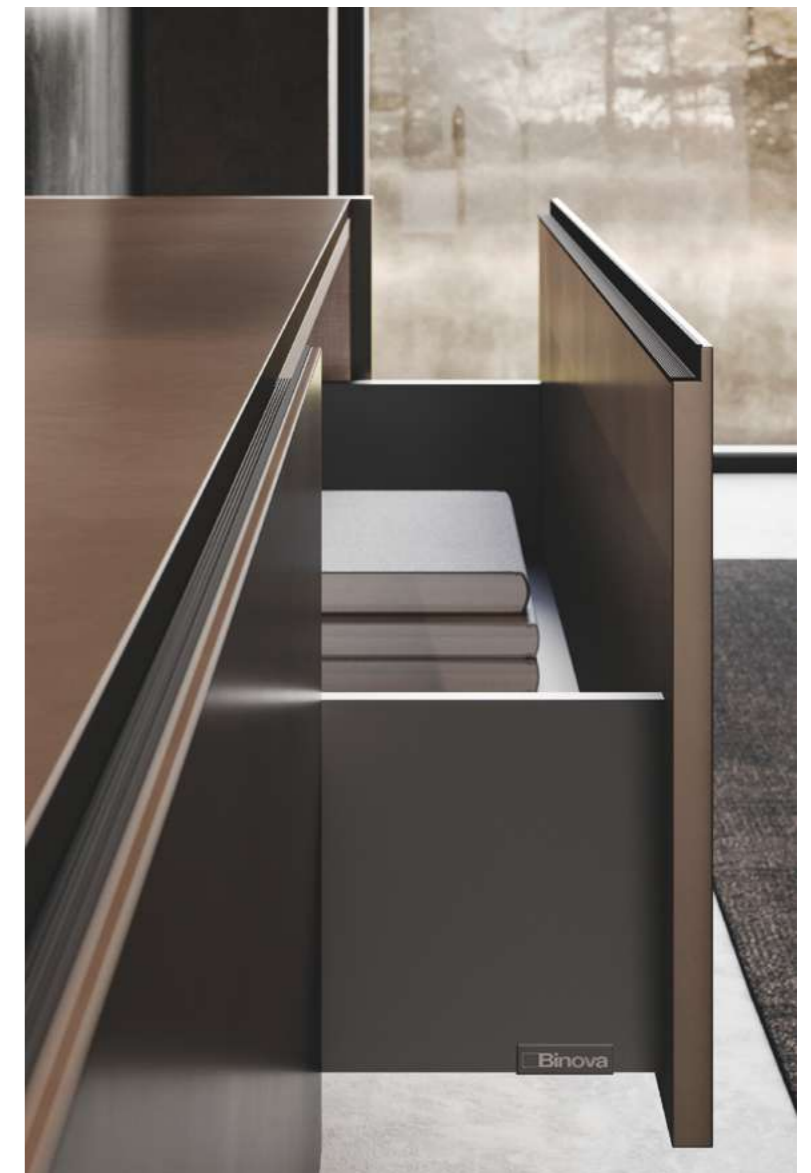





DETTAGLIO MADIA  
CON ANTE MILES  
IN VETRO FUME' E  
TELAIO IN FINITURA  
ALLUMINIO NERO.  
STRUTTURA INTERNA  
IN FINITURA  
BILAMINATO ROVERE  
LAVA CON SCHIENA  
IN FINITURA GREY  
FABRIC. PIANO  
IN GRES OPACO  
FINITURA MARBLE  
GREY.

DETAIL OF  
SIDEBOARD WITH  
MILES DOORS MADE  
IN FUME' GLASS AND  
BLACK ALUMINIUM  
FRAME. INTERNAL  
STRUCTURE IS IN  
WOOD BILAMINATE  
ROVERE LAVA AND  
BACK PANEL IS IN  
GREY FABRIC FINISH.  
PLANE IN MATT  
GRES MARBLE GREY  
FINISH.

DETAIL BUFFET  
AVEC FAÇADES  
MILES EN VERRE  
FUME ET CADRE EN  
FINITION ALUMINIUM  
NOIR. STRUCTURE  
INTERNE EN FINITION  
BILAMINE ROVERE  
LAVA AVEC DOS  
EN FINITION GREY  
FABRIC. PLAN DE  
TRAVAIL EN GRÈS MAT  
FINITION MARBLE  
GREY.

DETALLE DEL APARADOR  
CON PUERTAS DE  
MILLAS HECHAS EN  
VIDRIO DE FUMA Y  
MARCO DE ALUMINIO  
NEGRO. LA ESTRUCTURA  
INTERNA ESTÁ EN  
MADERA BILAMINADA  
ROVERE LAVA Y EL  
PANEL POSTERIOR  
ESTÁ EN ACABADO DE  
TELA GRIS. PLANO EN  
ACABADO GRIS MÁRMOL  
GRIS MATE.



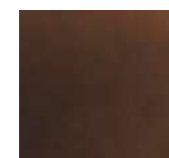

LACCATO METAL  
4.0 BRONZO

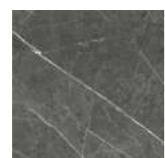

GRES MARBLE GREY  
OPACO



BILAMINATO  
LEGNO ROVERE  
LAVA



LACCATO OPACO  
NERO TRAFFICO



BILAMINATO  
STRUTTURA NERO  
CARBONE



VETRO FUMÈ E  
ALLUMINIO NERO

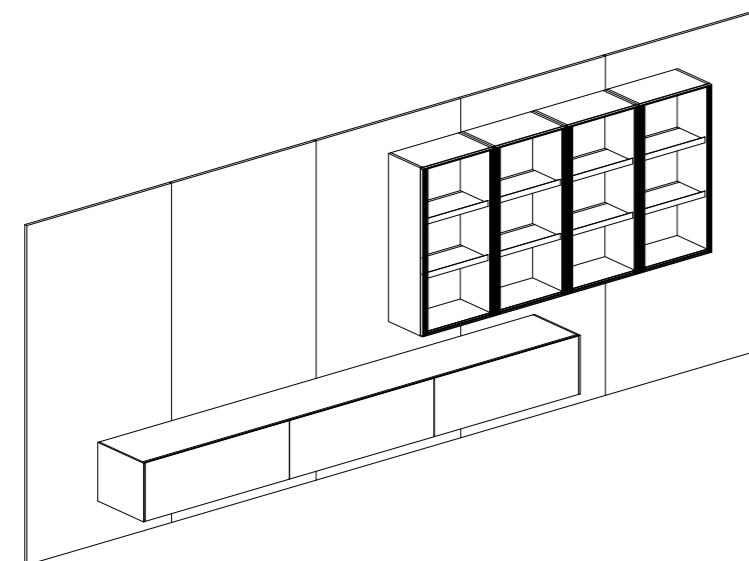

**PARETE LIVING LIVING WALL**

L 480 H 235,5 P 47,5/35,5

BLUNA LACCATO METAL 4.0 BRONZO CON MANIGLIA GAP NERA  
VETRINE MILES TELAIO NERO E VETRO FUMÈ, STRUTTURA  
BILAMINATO LEGNO ROVERE LAVA  
SCHIENALE BILAMINATO LEGNO ROVERE LAVA

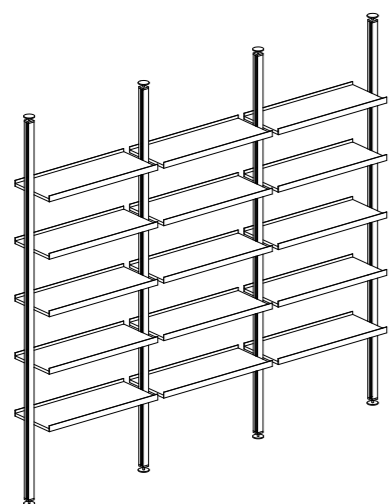

**LIBRERIA PIVOT LIBRARY**

L 290 CM H 270 P 35

RIPIANI BILAMINATO LEGNO ROVERE LAVA  
PALI ALLUMINIO NERO OPACO

**BLUNA METAL 4.0**

**SCHEDA TECNICA DATA SHEET**  
**FICHE TECHNIQUE FICHA DE DATOS**

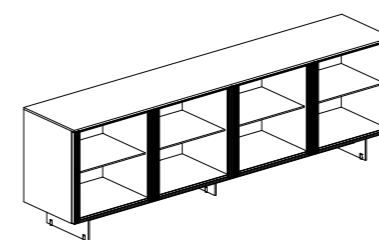

**MADIA SIDEBORD**

L. 240 H. 75 P. 47,5

VETRINE MILES TELAIO NERO E VETRO FUMÈ, STRUTTURA  
BILAMINATO LEGNO ROVERE LAVA  
TOP GRES MARBLE GREY OPACO  
BASAMENTO CUT METALLO NERO OPACO

84

85

**AVOLA** GRES



## AVOLA GRES

87

Un atto di grande libertà: quella del design minimalista che apre alla percezione di un'essenza marmorea che corre lungo i profili e le venature, segni precisi che diventano traccia comune e viva nel contrasto del chiaroscuro e nell'equilibrio costante tra l'estetica d'insieme e il punto del dettaglio. L'espansione di movimento diventa totale grazie al telaio in alluminio, che accoglie comodamente il pannello centrale ed al contempo consente la presa su tutti i lati. La parete living è costituita da contenitori sospesi Avola in finitura gres rigato mentre sulla parte superiore si snoda un piano sospeso in legno al quale viene associato un pensile metrico dello stesso materiale. La madia ripercorre le stesse finiture marmoree e fa da sfondo alla zona pranzo con vetrine alte e tavolo in legno. This is an expression of real liberty: the minimalist design is free to run with its vivid essence along contours and grain, sharp lines that become a common sign, living in the light and shade, balancing the global aesthetics and the slightest particulars. A model that is expansion: thanks to the aluminum frame, which comfortably allow space for the central panel and at the same time allows opening on every side. The living wall is made up of Avola suspended containers in a striped gres finish, while on the upper part there is a suspended wooden top to which a metric wall unit of the same material is associated. The sideboard traces the same marble finishes and acts as a background to the dining area with tall display cabinets and wooden table.





DETTAGLIO LIVING  
CON ANTE TELAIO  
IN FINITURA  
ALLUMINIO NERO E  
PANNELLO CENTRALE  
IN FINITURA GRES  
INSIDE PIETRA  
PIASENTINA GRIGIA  
FIAMMATA, TOP E  
PENSILE METRICO IN  
FINITURA LEGNO NOCE  
CANALETTO, BOISERIE  
LEAF IN FINITURA  
LACCATO OPACO  
GRIGIO ANTRACITE.

DETAIL OF LIVING  
AREA WITH BLACK  
ALUMINIUM FRAME  
DOORS AND CENTRAL  
PANEL INSIDE GRES  
PIETRA PIASENTINA  
FIAMMATA FINISH,  
TOP AND METRIC  
WALL UNIT IS IN  
WOOD CANALETTO  
WALNUT FINISH,  
BOISERIE LEAF IS IN  
MATT LACQUERED  
GRIGIO ANTRACITE  
FINISH.

DETAIL LIVING  
AVEC PORTES AVEC  
CADRE EN FINITION  
ALUMINIUM NOIR ET  
PANNELLO CENTRAL  
EN FINITION GRES  
INSIDE PIETRA  
PIASENTINA GRIGIA  
FIAMMATA, PLAN ET  
MEUBLE METRIQUE EN  
FINITION BOIS NOCE  
CANALETTO, BOISERIE  
LEAF EN FINITION  
LAQUE MAT GRIGIO  
ANTRACITE.

DETALLE PARED LIVING  
CON PUERTAS DE  
MARCO EN ACABADO  
ALUMINIO NERO Y  
PANEL CENTRAL EN  
ACABADO GRES INSIDE  
PIEDRA PIASENTINA  
GRIS LLAMA ,  
ENCIMERA Y MUEBLE  
MÉTRICO ENCHAPADO  
DE MADERA ACABADO  
NOCE CANALETTO,  
BOISERIE LEAF LACA  
MATE ACABADO GRIGIO  
ANTRACITE.





92

93



DETTAGLIO COLONNE  
CON ANTE REFLEX IN  
VETRO FUME' E TELAIO  
IN FINITURA ALLUMINIO  
NERO OPACO.

DETAIL OF COLUMN  
WITH REFLEX DOORS  
MADE IN FUME'  
GLASS AND BLACK  
ALUMINUM FRAME.

DETAIL COLONNE  
AVEC PORTES REFLEX  
EN VERRE FUME ET  
CADRE EN FINITION  
ALUMINIUM NOIR MAT.

DETALLES DE COLUMNAS  
CON PUERTAS REFLEX  
EN VIDRIO FUME' Y  
MARCO EN ACABADO DE  
ALUMINIO NERO MATE.

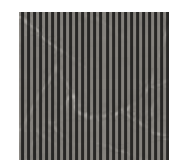

GRES INSIDE  
PIETRA PIASENTINA  
GRIGIO FIAMMATO  
RIGATO

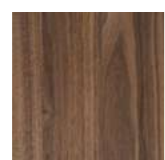

LEGNO SPECIALE  
NOCE CANALETTO



LACCATO OPACO  
GRIGIO ANTRACITE

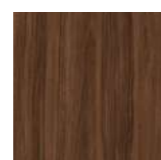

BILAMINATO  
LEGNO NOCE  
AMERICANO

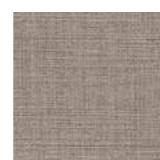

BILAMINATO  
STRUTTURA GREY  
FABRIC



VETRO FUMÉ E  
ALLUMINIO NERO

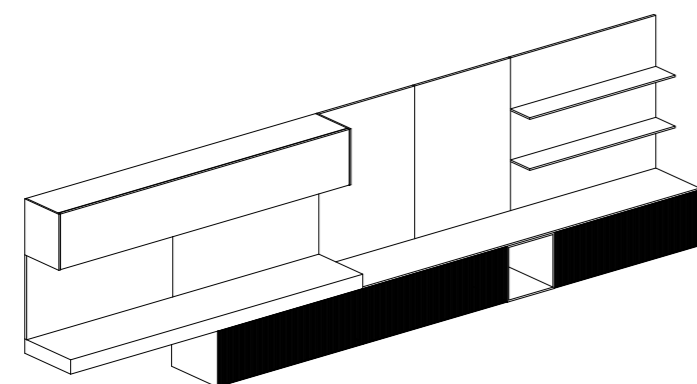

**PARETE LIVING LIVING WALL**

L 522 H 147 P 47,5

AVOLA GRES INSIDE PIETRA PIASENTINA GRIGIO  
FIAMMATO RIGATO CON TELAIO NERO OPACO  
BOISERIE LEAF LACCATO OPACO GRIGIO ANTRACITE  
BLUNA LEGNO SPECIALE NOCE CANALETTO

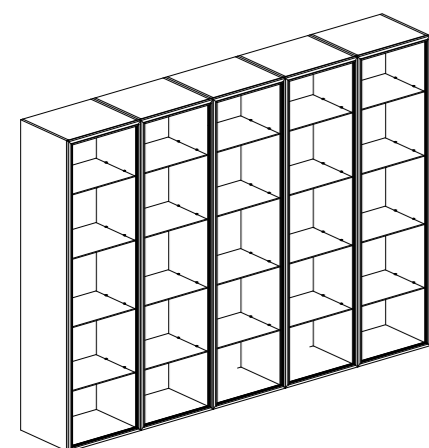

**VETRINE REFLEX GLASS UNITS**

L 300 CM H 216 P 47,5

VETRINE REFLEX CON TELAIO NERO E VETRO FUMÉ  
STRUTTURA INTERNA BILAMINATO LEGNO NOCE AMERICANO

**AVOLA GRES**

**SCHEDA TECNICA DATA SHEET  
FICHE TECHNIQUE FICHA DE DATOS**

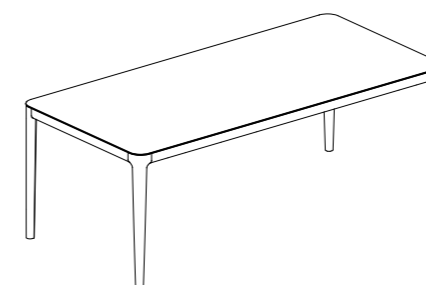

**TAVOLO FIRENZE 02 TABLE**

L. 210 H. 76 P. 100

TOP GRES PIETRA PIASENTINA GRIGIO FIAMMATO  
STRUTTURA LEGNO FRASSINO MIELE

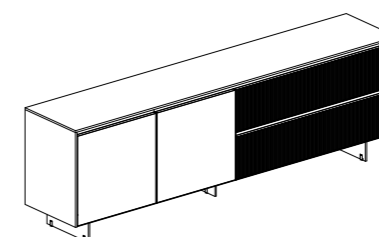

**MADIA SIDEBOARD**

L. 242,4 H. 79 P. 47,5

AVOLA GRES INSIDE PIETRA PIASENTINA GRIGIO FIAMMATO  
RIGATO CON TELAIO NERO OPACO  
TOP E FIANCHI LEGNO SPECIALE NOCE CANALETTO  
TOP GRES GRES INSIDE PIETRA PIASENTINA GRIGIO FIAMMATO  
BASAMENTO CUT METALLO NERO OPACO



96

97

**MANTIS** + BLUNA



## MANTIS + BLUNA

99

Mantis è il momento in cui il progetto si sostituisce all'elemento architettonico, in cui gli arredi che una volta separavano ora creano un continuum: la fluidità degli ambienti diventa logica, mentre l'espressione della tecnologia arriva persino ad alleggerire il metallo, rendendo l'insieme degli elementi più raffinato e al contempo più forte e persistente. Andare oltre la possibilità di uno spazio così come ci è dato non è privilegio: è talento. Scomporre lo sguardo significa creare pareti per tracciare uno spazio di vita che sia unico eppure quotidiano. Significa concepire un sistema di linee pure talmente personale in cui riconoscersi da ogni punto di vista. Mantis è un progetto di architettura integrata che porta ai massimi livelli l'evoluzione di tecnologia e spazio, laddove quest'ultimo è espanso in termini di uso e di tempo. L'unione di concetti polari è una cifra costante che si proietta sulla leggerezza degli altissimi frontali resa possibile da ante in alluminio di spessore 12 millimetri realizzate in alveolare di alluminio e rivestite con differenti materiali. Mantis is a design, taking place of the architectural elements: what once used to separate now is a connection, and the continuity of the spaces becomes a logic consequence. We enhance all the many possibilities that advanced technology delivers, like lightening the strong metal frame to obtain a thinner and persistent product. Improving the resources of a given space is not a chance: it is a real talent. Syllabizing the glance means creating new walls that mark a unique space made out of the essence of our daily life. It is the concept of a whole living system expressed with such pure and universal lines, so personal that it will clearly tell something about us anywhere our gaze will turn. Mantis is an incorporated architecture project representing the evolution of technology and space concepts, as space itself is an extension of time and using capability. The union of polar concepts is the key to read the tall frontals we have created thanks to the 12 mm thick aluminium doors.





DETTAGLIO LIVING  
CON ANTE MANTIS IN  
FINITURA LACCATO  
OPACO BEIGE KENIA,  
PIANO IN GRES TAJ  
MAHAL OPACO E  
SCHIENALE IN LEGNO  
ROVERE CARBONE.

DETAIL OF LIVING AREA  
WITH MANTIS DOORS  
MATT LACQUERED BEIGE  
KENIA, TOP IN MATT  
GRES TAJ MAHAL FINISH  
AND BACK PANEL IN  
WOOD ROVERE CARBONE  
FINISH.

DETAIL LIVING AVEC  
PORTES MANTIS EN  
FINITION LAQUE  
MAT BEIGE KENIA,  
PLAN EN GRES TAJ  
MAHAL MAT ET DOS  
EN FINITION BOIS  
ROVERE CARBONE.

DETALLE PARED LIVING  
CON PUERTAS MANTIS EN  
ACABADO LACADO BEIGE  
KENIA MATE, ENCIMERA  
EN GRES ACABADO TAJ  
MAHAL MATE Y ESPALDA  
EN MADERA ROVERE  
CARBONE.

102

103





104

105

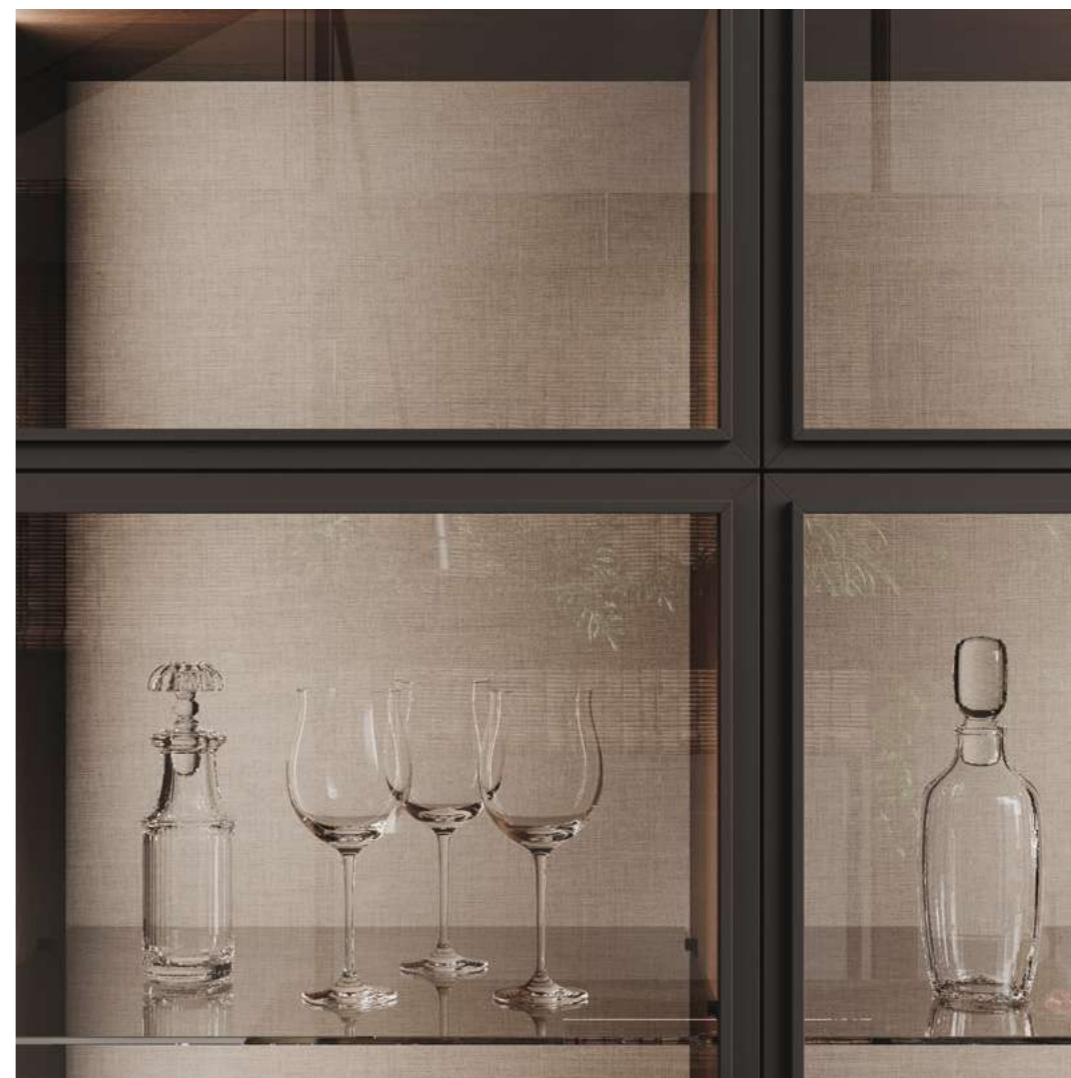

DETTAGLIO COLONNE  
CON ANTE REFLEX  
IN VETRO FUME' E  
TELAIO IN FINITURA  
ALLUMINIO NERO.  
STRUTTURA INTERNA  
IN FINITURA  
BILAMINATO NOCE  
MONZA CON SCHIENA  
IN FINITURA GREY  
FABRIC.

DETAIL OF COLUMNS  
WITH REFLEX  
DOORS MADE IN  
FUME' GLASS AND  
BLACK ALUMINUM  
FRAME. INTERNAL  
STRUCTURE IS IN  
WOOD BILAMINATE  
NOCE MONZA AND  
BACK PANEL IS IN  
GREY FABRIC FINISH.

DETAIL COLONNES  
AVEC PORTES  
REFLEX EN VERRE  
FUME ET CADRE EN  
FINITION ALUMINIUM  
NOIR. STRUCTURE  
INTERNE EN FINITION  
BILAMINE NOCE  
MONZA AVEC DOS  
EN FINITION GREY  
FABRIC.

DETALLES DE COLUMNAS  
CON PUERTAS REFLEX  
EN VIDRIO FUME' Y  
MARCO EN ACABADO DE  
ALUMINIO NERO MATE.  
ESTRUCTURA INTERNA  
EN BILAMINADO DE  
MADERA ACABADO NOCE  
MONZA CON ESPALDA  
EN ACABADO GREY  
FABRIC.

DETTAGLIO MADIA  
IN FINITURA  
LACCATO LUCIDO  
BEIGE KENIA ED  
INSERTO IN FINITURA  
LEGNO ROVERE  
TERMOTRATTATO.  
BASAMENTO VERNICIATO  
NERO OPACO.

DETAIL OF SIDEBOARDS  
IN GLOSSY LACQUERED  
BEIGE KENIA FINISH  
AND INSERT IN  
OAK WOOD ROVERE  
TERMOTRATTATO  
FINISH. LOWER  
STRUCTURE MATT  
BLACK FINISH.

DETAIL BUFFET EN  
FINITION LAQUE  
BRILLANT BEIGE  
KENIA ET INSERTS  
EN FINITION  
BOIS ROVERE  
TERMOTRATTATO,  
BASE VERNIE EN  
FINITION NOIR MAT.

DETALLE APARADOR  
EN LACADO BRILLANTE  
ACABADO BEIGE  
KENIA E INSERTE  
EN ENCHAPADO DE  
MADERA ROVERE  
TERMOTRATADO.  
BASE PINTADA NEGRA  
MATE.

106

107



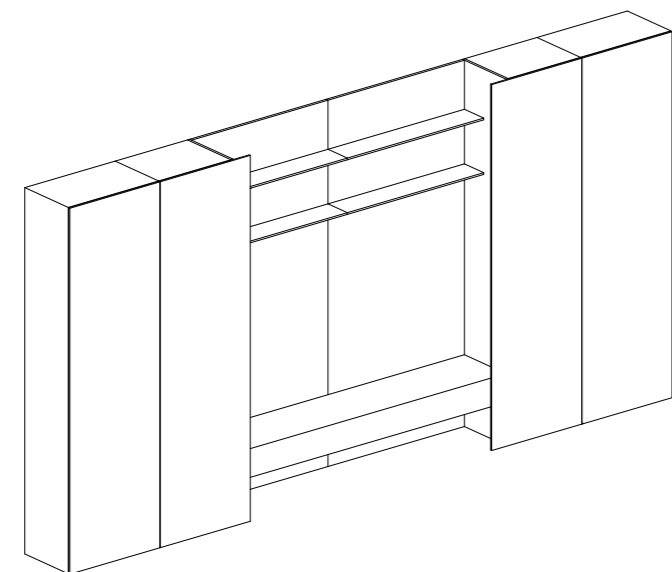

**PARETE LIVING** LIVING WALL

L 500 H 255 P 47,5

MANTIS LACCATO OPACO BEIGE KENIA  
BOISERIE LEAF LEGNO ROVERE CARBONE CON MENSOLE  
LACCATO OPACO NERO TRAFFICO  
PIANO SOSPESO GRES TAJ MAHAL OPACO

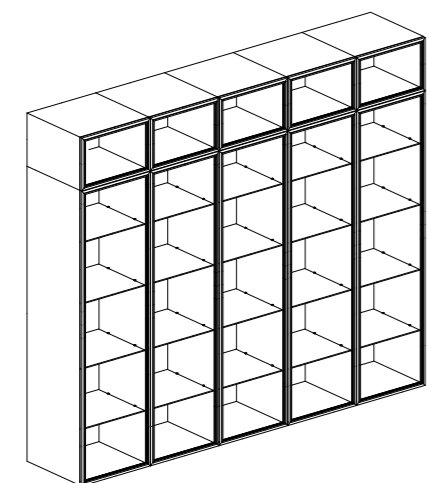

**VETRINE REFLEX** GLASS UNITS

L 300 CM H 255 P 47,5

VETRINE REFLEX CON TELAIO NERO E VETRO FUMÉ  
STRUTTURA INTERNA BILAMINATO LEGNO NOCE MONZA

**MANTIS + BLUNA**

**SCHEDA TECNICA DATA SHEET**  
**FICHE TECHNIQUE FICHA DE DATOS**



**TAVOLO MOOR 01** TABLE

L. 150 H. 76 P. 150

TOP GRES TAJ MAHAL OPACO  
STRUTTURA LEGNO FRASSINO CARBONE E  
SOTTOPIANA LACCATO OPACO NERO TRAFFICO

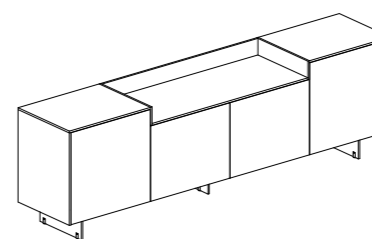

**MADIA** SIDEBOARD

L. 242,4 H. 76 P. 47,5

BLUNA LACCATO LUCIDO BEIGE KENIA  
VASCA LEGNO ROVERE TERMOTRATTATO  
BASAMENTO CUT METALLO NERO OPACO

110

111

**REFLEX** + VOGUE





## REFLEX + VOGUE

113

Un grande spazio living caratterizzato da una parete divisa in due parti, una piena adibita ad accogliere la zona pranzo contenente un lungo camino ed un tavolo davanti ad esso e l'altra svuotata costituita da vetrine sospese in una boiserie di metallo che sovrastano un piano in legno poggiato a terra. Lo spazio è libero ed al contempo organizzato, i volumi si compensano a vicenda e fanno sì che ogni cosa possa essere riposta al proprio posto. Sul lato destro spicca la madia Vogue, progetto di punta della collezione, consiste in un gioco di pieni e vuoti dato dai frontali con maniglie ricavate all'interno del bordo verticale. E' caratterizzato oltremodo dalla speciale finitura a doghe sfalsate che esalta l'andamento scostante al ripetersi dei frontali di eguale misura. A large living space characterized by a wall divided into two parts, one full used to accommodate the dining area containing a long fireplace and a table in front of it and the other emptied consisting of a display cabinet suspended in a metal boiserie overlooking a wood resting on the ground. The space is free and at the same time organized, the volumes compensate each other and ensure that everything can be put back in its place. On the right side stands the Vogue sideboard, the collection's flagship project, consisting of a play of solids and voids given by the fronts with handles obtained inside the vertical edge. It is extremely characterized by the special staggered slot finish that enhances the unfriendly trend with the repetition of fronts of equal size.



DETTAGLIO MADIA  
CON ANTE VOGUE  
LEGNO IN FINITURA  
ROVERE VESUVIO  
DOGA SFALSATA E  
TOP IN GRES INSIDE  
FINITURA PIETRA  
PIASENTINA GRIGIO  
FIAMMATO.

DETAIL OF SIDEBOARD  
WITH VOGUE DOORS  
WOOD ROVERE  
VESUVIO DOGA  
SFALSATA FINISH,  
WORKTOP INSIDE  
GRES PIETRA  
PIASENTINA GRIGIO  
FIAMMATO FINISH.

DETAIL BUFFET AVEC  
FAÇADES VOGUE BOIS  
EN FINITION ROVERE  
VESUVIO AVEC LATTES  
IRREGULIERES ET  
PLAN EN GRES INSIDE  
FINITION PIETRA  
PIASENTINA GRIGIO  
FIAMMATO.

DETALLE APARADOR  
CON PUERTAS  
VOGUE MADERA EN  
ACABADO DE ROVERE  
VESUVIO CON LISTON  
ESCALONADO Y  
ENCIMERA EN GRES  
INSIDE PIETRA  
PIASENTINA LLAMA.

116

117





BLUNA + VOGUE

SCHEDA TECNICA DATA SHEET  
FICHE TECHNIQUE FICHA DE DATOS

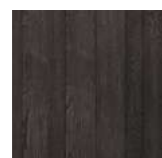

LEGNO SPECIALE  
ROVERE VESUVIO  
DOGA SFALSATA

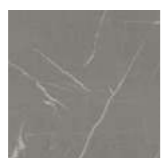

GRES INSIDE  
PIETRA PIASENTINA  
GRIGIO FIAMMATO

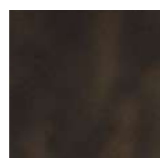

BILAMINATO  
MATERICO  
METALLO NUVOLA

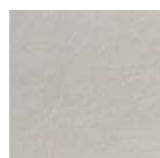

BILAMINATO  
MATERICO BETON  
ARGILLA

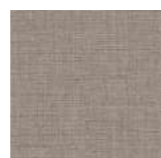

BILAMINATO  
STRUTTURA GREY  
FABRIC



VETRO FUMÉ E  
ALLUMINIO NERO

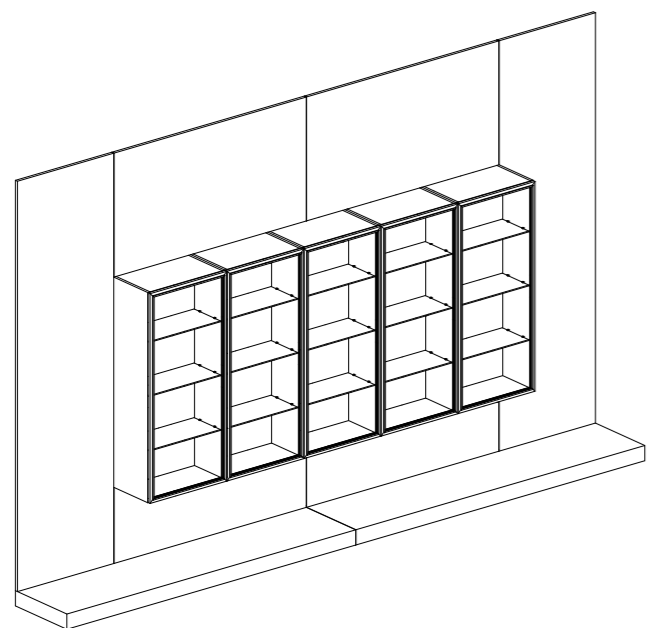

PARETE LIVING LIVING WALL

L 300 H 200 P 35,5

VETRINE REFLEX TELAIO NERO E VETRO FUMÉ, STRUTTURA BILAMINATO MATERICO BETON ARGILLA  
PIANO FOLDING A TERRA LEGNO ROVERE VESUVIO DOGA SFALSATA  
SCHIENALE BILAMINATO MATERICO BETON NUVOLA

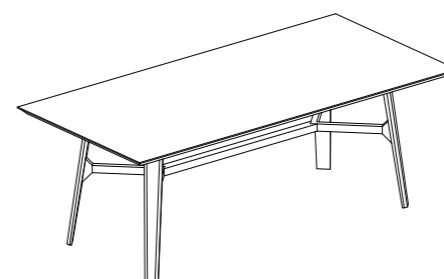

TAVOLO MOOR 02 TABLE

L. 200 H. 76 P. 100

TOP GRES PIETRA PIASENTINA GRIGIO FIAMMATO OPACO  
STRUTTURA LEGNO FRASSINO CARBONE E SOTTOPIANA  
LACCATO OPACO NERO TRAFFICO

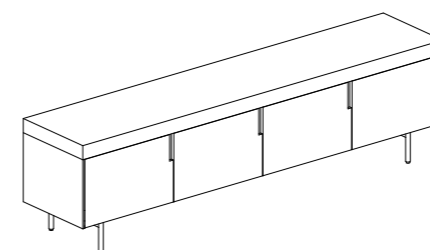

MADIA SIDEBOARD

L. 242,4 H. 69 P. 47,5

VOGUE LEGNO ROVERE VESUVIO DOGA SFALSATA  
TOP GRES PIETRA PIASENTINA GRIGIO FIAMMATO OPACO  
BASAMENTO ROUND METALLO NERO OPACO

122

123

**BLUNA** LEGNO



## BLUNA LEGNO

125

L'idea di un ambiente conviviale è al centro di questo progetto, uno spazio attorno al quale vivere ogni momento in compagnia e dove nulla è celato ma tutto è visibile ed aperto alla condivisione. La parete living è caratterizzata da un alternarsi di piani sfalsati tra loro, a partire dal basso il piano in legno poggiato a terra crea uno speciale dinamismo arricchito ancor più dalle basi che richiamano la stessa finitura. Nella parte alta completano il gioco di volumi le vetrine illuminate e la boiserie con funzione di sostegno per la tv. Sul fondo spicca la zona pranzo nella quale delle colonne basse fanno quasi da partecipi commensali all'evento e corredano a pieno lo spazio grazie all'alternanza di pieni e vuoti data dall'alternanza di vetrine e boiserie. The idea of a convivial environment is at the center of this project, a space around which to live every moment in company and where nothing is hidden but everything is visible and open to sharing. The living wall is characterized by an alternation of staggered floors, starting from the bottom the wooden top resting on the ground creates a special dynamism enriched even more by the bases that recall the same finish. In the upper part, the play of volumes is completed by the illuminated windows and the boiserie with support function for the TV. At the back stands the dining area in which low columns almost act as diners at the event and fully complement the space thanks to the alternation of solids and voids given by the alternation of shop windows and wood paneling.







DETTAGLIO PARETE  
LIVING CON BASI  
SOSPESE IN FINITURA  
BLUNA LEGNO  
ROVERE GRIGIO  
LONDRA, PENSILI  
CON ANTE VETRO  
REFLEX CON TELAIO  
NERO E VETRO  
FUMÈ, SCHIENALI  
IN BILAMINATO  
MATERICO FINITURA  
PIETRA PIASENTINA.

DETAIL OF LIVING  
WALL WITH BASE UNITS  
BLUNA WOOD ROVERE  
GRIGIO LONDRA FINISH  
AND WALL UNITS  
WITH REFLEX GLASS  
DOORS MADE IN BLACK  
ALUMINUM FRAME  
AND FUMÈ GLASS,  
BACK PANELS ARE IN  
MATERIC BILAMINATE  
PIETRA PIASENTINA  
FINISH.

DETAIL LIVING  
AVEC MEUBLES BAS  
SUSPENDUS EN  
FINITION BLUNA  
BOIS ROVERE GRIGIO  
LONDRA, MEUBLES  
HAUTS EN VERRE  
REFLEX AVEC CADRE  
NOIR ET VERRE  
FUME', DOS EN  
BILAMINE MATERICO  
FINITION PIETRA  
PIASENTINA.

DETALLE PARED  
LIVING CON BAJOS  
SUSPENDIDOS BLUNA  
ENCHAPADO DE  
MADERA ACABADO  
ROVERE GRIGIO  
LONDRA, ALTOS  
EN VIDRIO RÉFLEX  
MARCO NERO VIDRIO  
FUME', ESPALDA  
EN BILAMINADO  
MATERICO ACABADO  
PIETRA PIASENTINA.

128

129



DETTAGLIO COLONNE  
BASSE CON ANTE  
BLUNA IN FINITURA  
LEGNO ROVERE  
GRIGIO LONDRA  
E ANTE IN VETRO  
REFLEX CON TELAIO  
NERO E VETRO FUMÈ.

DETAIL OF LOWER  
COLUMN IN BLUNA  
WOOD ROVERE GRIGIO  
LONDRA FINISH AND  
REFLEX GLASS DOORS  
MADE IN BLACK  
ALUMINUM FRAME  
AND FUMÈ GLASS.

DETAIL COLONNES  
BASSES AVEC FAÇADES  
BLUNA EN FINITION  
BOIS ROVERE GRIGIO  
LONDRA ET PORTES  
EN VERRE REFLEX  
AVEC CADRE NOIR ET  
VERRE FUMÈ.

DETTALLES COLUMNAS  
BAJAS CON PUERTAS  
BLUNA ENCHAPADO DE  
MADERA ACABADO ROVERE  
GRIGIO LONDRA Y PUERTAS  
EN VIDRIO REFLEX MARCO  
EN ACABADO DE ALUMINIO  
NERO MATE VIDRIO FUMÈ'.

130

131





BILAMINATO  
MATERICO PIETRA  
PIASENTINA

LEGNO ROVERE  
GRIGIO LONDRA

GRES INSIDE  
PIETRA PIASENTINA  
TAUPE FIAMMATO

BILAMINATO  
MATERICO BETON  
NUVOLA

BILAMINATO  
STRUTTURA NERO  
CARBONE

VETRO FUMÉ E  
ALLUMINIO NERO

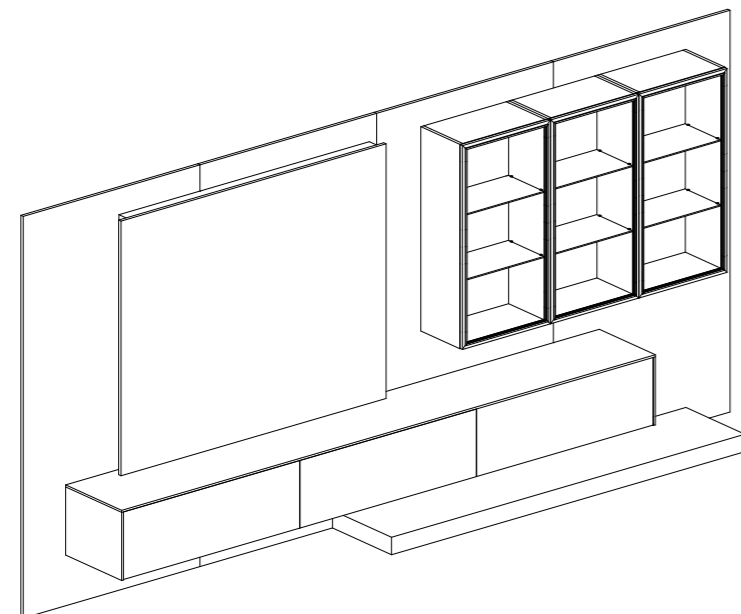

**PARETE LIVING** LIVING WALL

L 420 H 220 P 47,5

BLUNA LEGNO ROVERE GRIGIO LONDRA  
VETRINE REFLEX TELAIO NERO E VETRO FUMÉ, STRUTTURA BILAMINATO MATERICO BETON NUVOLA  
PIANO FOLDING A TERRA LEGNO ROVERE GRIGIO LONDRA  
SCHIENALE BILAMINATO MATERICO PIETRA PIASENTINA

**BLUNA LEGNO**

**SCHEDA TECNICA DATA SHEET**  
**FICHE TECHNIQUE FICHA DE DATOS**

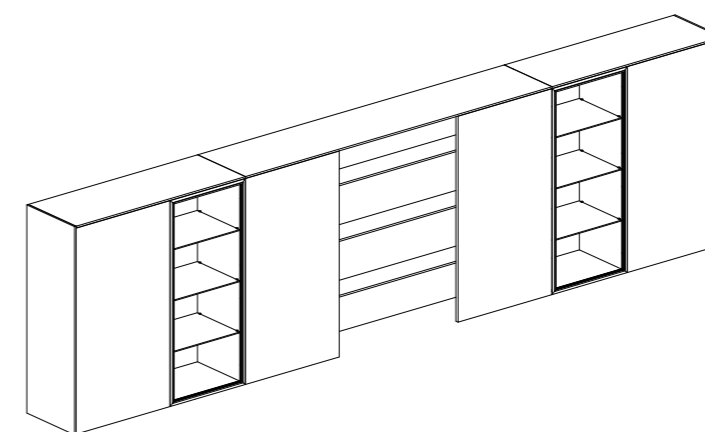

**PARETE SALA DA PRANZO** DINING ROOM WALL

L. 517 H. 138 P. 47,5

BLUNA LEGNO ROVERE GRIGIO LONDRA  
VETRINE REFLEX TELAIO NERO OPACO E VETRO FUMÉ,  
STRUTTURA INTERNA BILAMINATO MATERICO BETON NUVOLA  
BOISERIE LEAF LEGNO ROVERE GRIGIO LONDRA

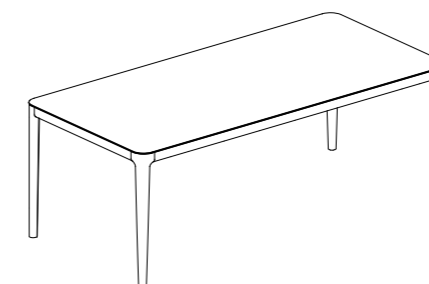

**TAVOLO FIRENZE 02** TABLE

L. 210 H. 76 P. 100

TOP GRES INSIDE PIETRA PIASENTINA TAUPE FIAMMATO OPACO  
STRUTTURA LEGNO FRASSINO MIELE

134

135

**VOGUE** + BLUNA



## VOGUE + BLUNA

137

Gli spazi smettono di essere limitati da elementi strutturali per diventare zone aperte e di passaggio, in cui non esiste più una vera gerarchia operativa. Un progetto che definisce così lo spirito di una casa aperta che non teme di offrire prospettive informali, dove il mutare della percezione dello spazio è un valore e non una stravaganza. L'elemento principale attorno al quale ruota l'intero ambiente è la parete colonne ad L costituita da moduli di diverse profondità uniti assieme per costituire un'unica linea che congiunge la cucina al living e che utilizza i medesimi elementi, un "continuum" di contaminazioni tra forme e funzioni. Altra forte caratteristica delle colonne sono le aperture che alleggeriscono l'impatto del muro in legno ed al contempo consentono l'apertura dei frontali e dei meravigliosi coni di luce. La madia con ante Vogue è caratterizzata da tagli verticali che consentono l'apertura e dalla finitura laccata ossidata. La parete living ripercorre le stesse finiture della cucina ed è caratterizzata da una intersezione di volumi che consentono pieni e vuoti con vani folding incassati, mentre la madia è con ante Vogue e top in gres alto spessore. Spaces are no longer limited by structural elements becoming open areas where an operating hierarchy doesn't exist anymore. A project that defines the spirit of an open home that is no longer afraid of an informal outlook, where the perception of space is changing, no longer an extravagance. The main element around which the entire room revolves is the L-shaped column wall made up of modules of different depths joined together to form a single line that connects the kitchen from the living room and uses the same elements, a "continuum" of contamination between forms and functions. Another strong feature of the columns are the openings that lighten the impact of the wooden wall and at the same time allow the opening of the fronts and the wonderful light cones. The sideboard with Vogue doors is characterized by vertical cuts that allow opening and by 4.0 metal lacquered finish. The living wall traces the same finishes as the kitchen and is characterized by an intersection of volumes that allow full and empty spaces with recessed folding open units, while the sideboard is with Vogue doors and top in thick gres.





DETTAGLIO PARETE  
LIVING CON ANTE  
BLUNA LACCATO  
METAL 4.0 FINITURA  
AMARANTO, COLONNE  
IN BLUNA BILAMINATO  
LEGNO FINITURA NOCE  
MONZA E MODULI A  
GIORNO FOLDING  
NERO OPACO.

DETAIL OF LIVING  
WITH BLUNA  
DOORS IN 4.0  
METAL LACQUERED  
AMARANTO FINISH,  
COLUMNS IN BLUNA  
WOOD BILAMINATE  
NOCE MONZA FINISH  
AND FOLDING OPEN  
SPACE UNITS MATT  
BLACK FINISH.

DETAIL MUR LIVING  
AVEC FAÇADES  
BLUNA LAQUEES  
METAL 4.0 FJNITION  
ROSSO AMARANTO,  
COLONNES BLUNA  
BILAMINE BOIS  
FINITION NOCE  
MONZA ET MEUBLES  
OUVERTS FOLDING  
NOIR MAT.

DETALLE PARED LIVING  
CON PUERTAS LACADO  
METAL 4.0 ACABADO  
ROJO AMARANTO,  
COLUMNAS BLUNA  
BILAMINADO DE  
MADERA ACABADO NOCE  
MONZA Y MÓDULOS  
ABIERTOS PLEGABLES  
NEGRO MATE.





DETTAGLIO MADIA IN  
LACCATO METAL 4.0  
FINITURA AMARANTO,  
TOP IN GRES  
FINITURA BRECCIA  
CAPRAIA OPACO.

DETAIL OF SIDEBOARD  
IN METAL 4.0  
LACQUERED AMARANTO  
FINISH, TOP IN MATT  
GRES BRECCIA CAPRAIA  
FINISH.

DETAIL OF SIDEBOARD  
IN METAL 4.0  
LACQUERED AMARANTO  
FINISH, TOP IN MATT  
GRES BRECCIA CAPRAIA  
FINISH.

DETAIL OF SIDEBOARD  
IN METAL 4.0  
LACQUERED AMARANTO  
FINISH, TOP IN MATT  
GRES BRECCIA CAPRAIA  
FINISH.





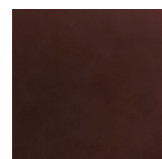

LACCATO METAL  
4.0 AMARANTO

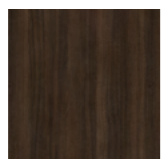

BILAMINATO  
LEGNO NOCE  
MONZA



GRES BRECCIA  
CAPRAIA OPACO



TECH NERO ONICE  
OPACO

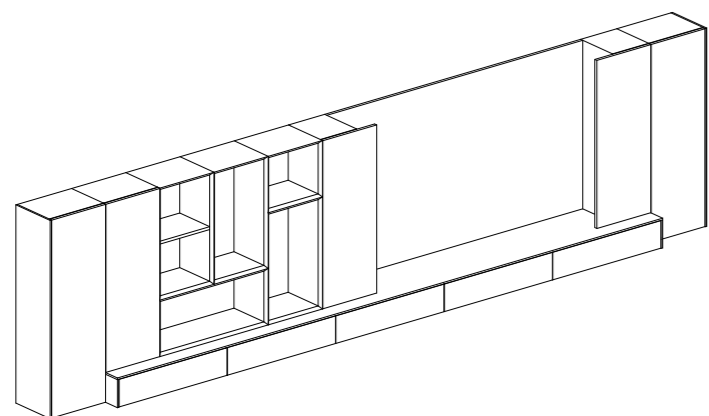

**PARETE LIVING** LIVING WALL

L 545 H 138 P 47,5/35,5

BLUNA LACCATO METAL 4.0 AMARANTO  
BLUNA BILAMINATO LEGNO NOCE MONZA  
OPEN SPACE FOLDING TECH NERO ONICE OPACO

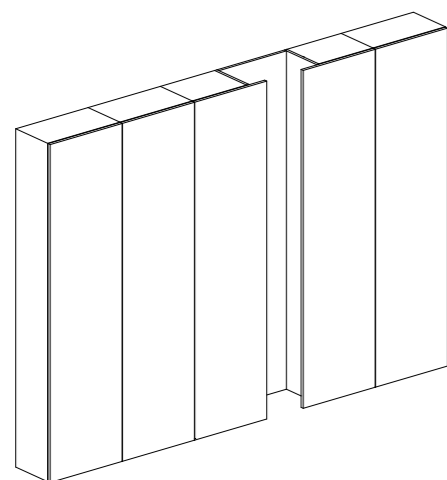

**PARETE SALA DA PRANZO** DINING ROOM WALL

L 330 CM H 235,5 P 35,5

BLUNA BILAMINATO LEGNO NOCE MONZA  
NICCHIA LUMINOSA LACCATO METAL 4.0 AMARANTO

**VOGUE + BLUNA**

**SCHEDA TECNICA DATA SHEET**  
**FICHE TECHNIQUE FICHA DE DATOS**

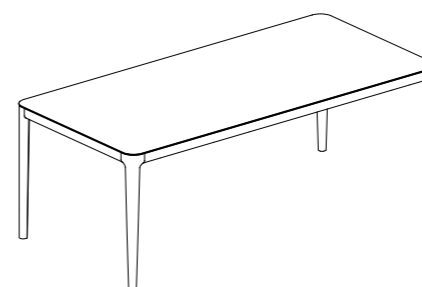

**TAVOLO FIRENZE 02** TABLE

L. 210 H. 76 P. 100

TOP GRES BRECCIA CAPRAIA OPACO  
STRUTTURA LEGNO FRASSINO CARBONE

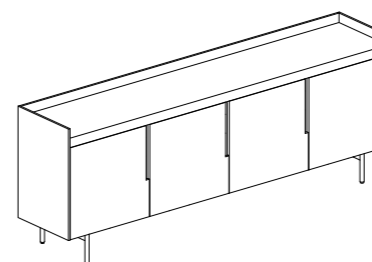

**MADIA** SIDEBOARD

L. 242,4 H. 90 P. 47,5

VOGUE LACCATO METAL 4.0 AMARANTO  
VASSOIO CENTRALE GRES BRECCIA CAPRAIA OPACO  
BASAMENTO ROUND METALLO NERO OPACO

146

147

**BLUNA** TECH BRUNITO



## BLUNA TECH BRUNITO

149

Uno spazio puro ed elegante in cui le superfici bronzee prendono vita trasformandosi per creare differenti atmosfere in base al luogo nel quale vengono posti. L'essenzialità dei solidi, sottolineata dalle ante delle colonne e dalle basi con gola, non contrasta con le diverse materie traslucide che introducono ad innumerevoli e rigorosi riflessi. La parete living è caratterizzata da un gioco di volumi garantito per mezzo delle due profondità disponibili, in basso le basi in tech, in alto le colonne in bilaminato legno ed infine la boiserie con funzione di sostegno per la tv. La medesima contaminazione materica si ritrova nella madia dai riflessi bronzee che accompagna il tavolo tondo. A pure and elegant space in which bronze surfaces come to life, transforming themselves to create different atmospheres based on the place in which they are placed. The essentiality of the solids, emphasized by the doors of the columns and the bases with grooves, does not contrast with the different translucent materials that introduce countless and rigorous reflections. The living wall is characterized by a play of volumes guaranteed by the two available depths, the tech bases at the bottom, the bilaminate wood columns at the top and finally the boiserie with support function for the TV. The same material contamination is found in the sideboard with bronze reflections that accompanies the round table.



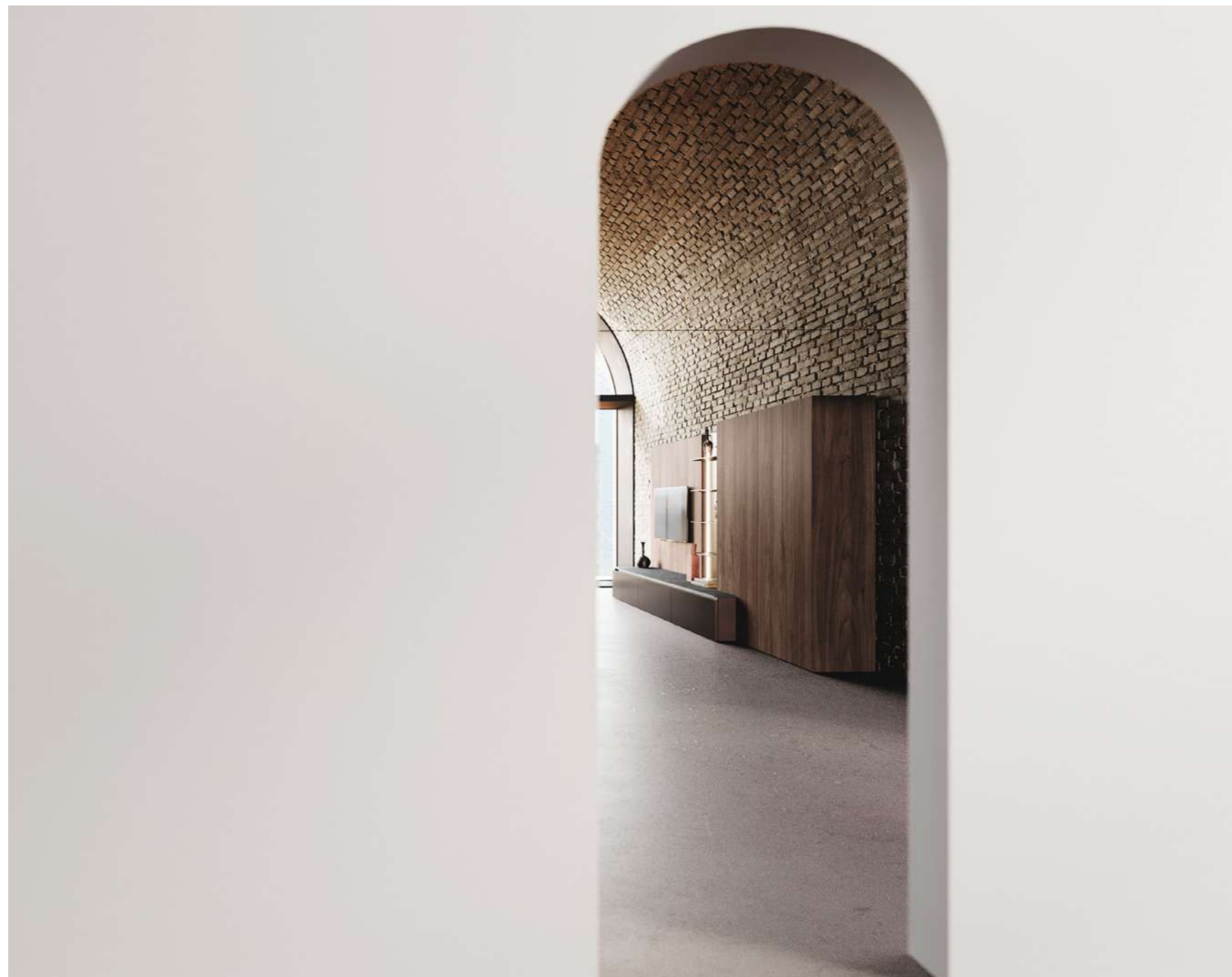

DETTAGLIO LIVING  
CON ANTE BLUNA  
TECH IN FINITURA  
ALLUMINIO BRUNITO  
CON PROFILO TRIM  
NERO E GOLA ELLE  
IN FINITURA NERO  
OPACO. TOP IN  
FINITURA GRES NERO  
GRECO OPACO SP.  
12 MM. COLONNE IN  
FINITURA BILAMINATO  
LEGNO NOCE CANTÙ.

DETAIL OF SIDEBOARD  
WITH BLUNA TECH  
DOOR ALLUMINIO  
BRUNITO FINISH  
WITH TRIM PROFILE  
AND ELLE GROOVE IN  
MATT BLACK FINISH.  
WORKTOP MATT GRES  
NERO GRECO FINISH  
12 MM THICKNESS.  
COLUMNS IN WOOD  
BILAMINATE NOCE  
CANTÙ FINISH.

DETAIL LIVING AVEC  
FAÇADES BLUNA  
TECH EN FINITION  
ALUMINIUM BRUNI  
AVEC PROFIL TRIM  
NOIR ET GORGE  
ELLE EN FINITION  
NOIR MAT. PLAN DE  
TRAVAIL GRES NERO  
GRECO MAT EP.12MM.  
COLONNES EN  
FINITION BILAMINE  
BOIS NOCE CANTÙ.

DETALLE PARED LIVING  
CON PUERTAS BLUNA  
TECH EN ACABADO DE  
ALUMINIO BRUNITO  
CON PERFIL TRIM  
NEGRO Y GOLA ELLE EN  
ACABADO NEGRO MATE.  
TOP EN GRES ACABADO  
NEGRO GRECO MATE  
SP. 12 MM. COLUMNAS  
EN ACABADO BLUNA  
BILAMINADO DE  
MADERA NOCE CANTÙ.

152

153

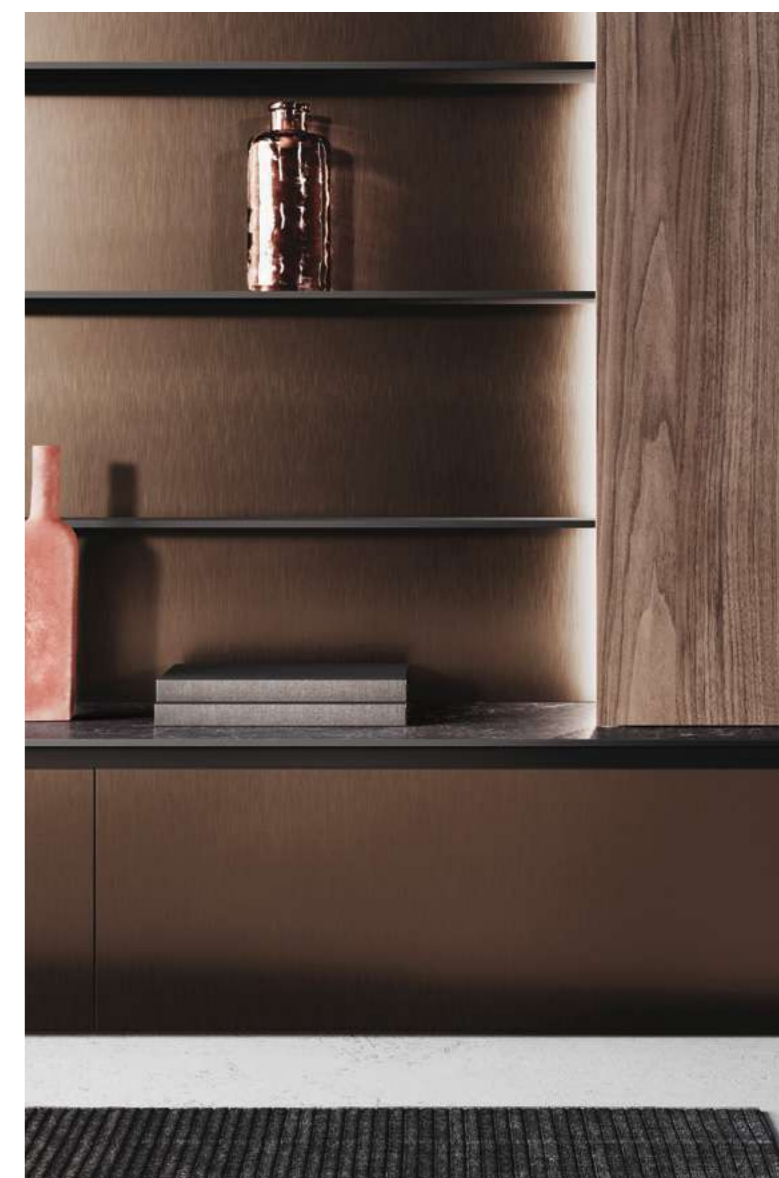

DETTAGLIO MADIA  
CON ANTE BLUNA  
TECH IN FINITURA  
ALLUMINIO BRUNITO  
CON PROFILO TRIM  
NERO E GOLA ELLE IN  
FINITURA NERO OPACO.  
TOP IN FINITURA GRES  
NERO GRECO OPACO SP.  
12 MM.

DETAIL OF SIDEBOARD  
WITH BLUNA TECH  
DOOR ALLUMINIO  
BRUNITO FINISH  
WITH TRIM PROFILE  
AND ELLE GROOVE IN  
MATT BLACK FINISH.  
WORKTOP MATT GRES  
NERO GRECO FINISH  
12 MM THICKNESS.

DETAIL BUFFET AVEC  
FAÇADES BLUNA  
TECH EN FINITION  
ALUMINIUM BRUNI  
AVEC PROFIL TRIM  
NOIR ET GORGE ELLE  
EN FINITION NOIR MAT.  
PLAN DE TRAVAIL EN  
FINITION GRES NERO  
GRECO MAT EP.12MM.

DETALLE APARADOR  
CON PUERTAS BLUNA  
TECH EN ACABADO DE  
ALUMINIO BRUNITO  
CON PERFIL TRIM  
NEGRO Y GOLA ELLE EN  
ACABADO MATE NEGRO.  
TOP EN GRES ACABADO  
NEGRO GRECO MATE SP.  
12 MM.

154

155

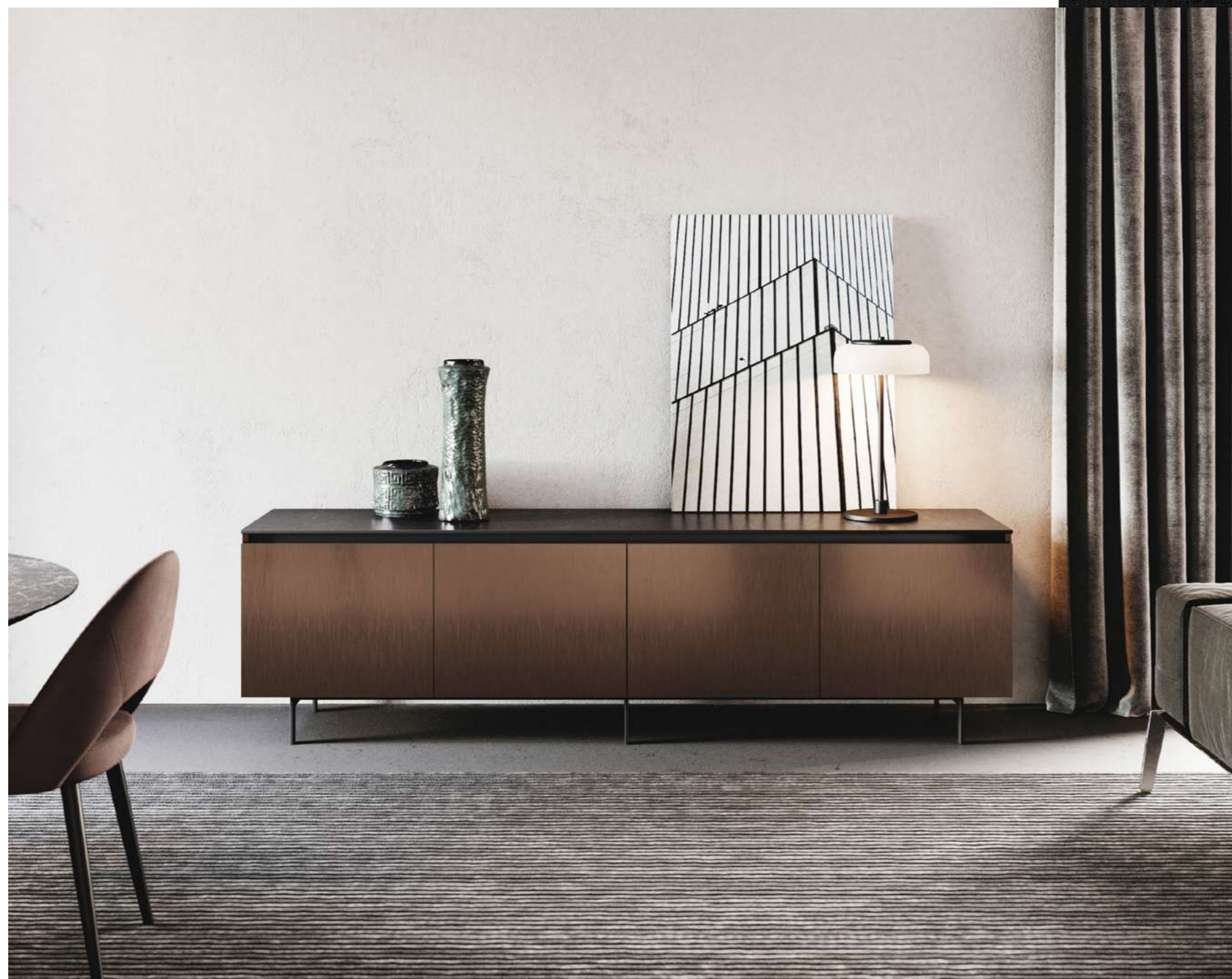

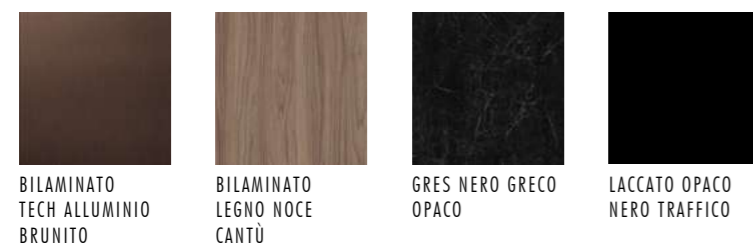

BILAMINATO  
TECH ALLUMINIO  
BRUNITO

BILAMINATO  
LEGNO NOCE  
CANTÙ

GRES NERO GRECO  
OPACO

LACCATO OPACO  
NERO TRAFFICO

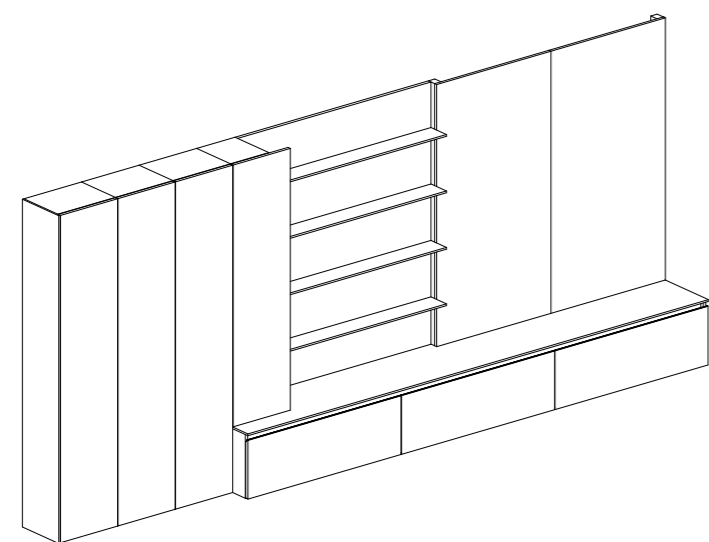

**PARETE LIVING** LIVING WALL

L. 495 H. 235,5 P. 47,5

BLUNA TECH ALLUMINIO BRUNITO  
BLUNA BILAMINATO LEGNO NOCE CANTÙ  
BOISERIE LEAF TECH ALLUMINIO BRUNITO CON MENSOLE LACCATO OPACO NERO TRAFFICO  
SCHIENALE BILAMINATO LEGNO NOCE CANTÙ  
TOP GRES NERO GRECO OPACO

**BLUNA TECH BRUNITO**

**SCHEDA TECNICA DATA SHEET**  
**FICHE TECHNIQUE FICHA DE DATOS**

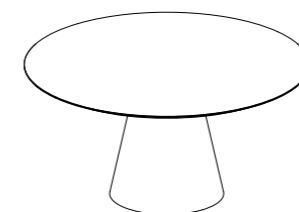

**TAVOLO PISA** TABLE

L. 150 H. 76 P. 150

TOP GRES NERO GRECO OPACO  
STRUTTURA LEGNO NOCE CANALETTO E SOTTOPIANA  
LACCATO OPACO TINTA NOCE

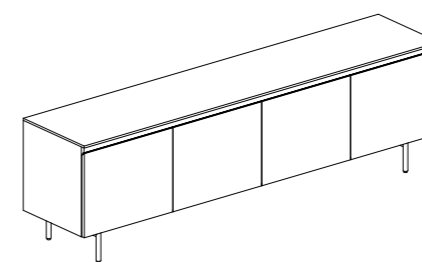

**MADIA** SIDEBOARD

L. 242,4 H. 85 P. 47,5

BLUNA TECH ALLUMINIO BRUNITO CON MANIGLIA TRIM NERA  
TOP GRES NERO GRECO OPACO  
BASAMENTO ROUND METALLO NERO OPACO

158

159

**BLUNA** TECH CHAMPAGNE





# BLUNA

TECH CHAMPAGNE

161

Un progetto che fa riscoprire il piacere di vivere un ambiente ricco di calore. La matericità del legno naturale conferisce una gradevole sensazione estetica e tattile, le ante delle colonne in Rovere carbone sono unite al tech alluminio delle basi: un insieme di materiali ad alto contenuto tecnologico che contribuisce a creare un prodotto unico nel suo genere. La parete viene altresì arricchita dalle vetrine quadrate disposte a cassettoni e corredate da ripiani luminosi per un effetto volumetrico unico nel suo genere. La madia ripercorre gli stessi materiali ed è caratterizzata da un piano alto in gres valorizzato dalla gola e dai fianchi a tutta altezza. L'intero progetto è incentrato sul tema delle aperture speculari, le colonne si aprono per dar luogo ad uno spazio centrale atto ad ospitare vetrine e schienali in legno. A project that makes you rediscover the pleasure of living in an environment full of warmth. The materiality of natural wood gives a pleasant aesthetic and tactile sensation, the doors of the tall units in Charcoal Oak are combined with the aluminum tech of the bases: a set of high-tech materials that helps to create a unique product of its kind. The wall is also enriched by square showcases arranged in drawers and accompanied by luminous shelves for a unique volumetric effect. The sideboard traces the same materials and is characterized by a high stoneware top enhanced by the throat and full-height sides. The entire project is centered on the theme of mirrored openings, the columns open to give rise to a central space capable of hosting display cabinets and wooden backs.





DETTAGLIO PARETE LIVING CON BASI IN FINITURA TECH ALLUMINIO CHAMPAGNE, PENSILI CON ANTE VETRO REFLEX COSTITUITO DA TELAIO IN ALLUMINIO NERO E VETRO FUMÈ, SCHIENALI E COLONNE IN LEGNO FINITURA ROVERE CARBONE.

DETAIL OF BASE UNITS IN TECH ALLUMINIO CHAMPAGNE FINISH AND WALL UNITS WITH REFLEX GLASS DOORS MADE IN BLACK ALUMINIUM FRAME AND FUMÈ GLASS, BACK PANELS AND COLUMNS ARE IN WOOD ROVERE CARBONE FINISH.

DETAIL MUR LIVING AVEC MEUBLES BAS EN FINITION TECH ALUMINIUM CHAMPAGNE, MEUBLES HAUTS AVEC FAÇADES EN VERRE REFLEX COMPOSE PAR UN CADRE EN ALUMINIUM NOIR ET VERRE FUME, DOS ET COLONNES EN BOIS FINITION ROVERE CARBONE.

DETALLE PARED LIVING CON BAJOS EN ACABADO TECH ALLUMINIO CHAMPAGNE, ALTOS CON PUERTAS DE VIDRIO REFLEX MARCO EN ACABADO DE ALUMINIO NEGRO Y VIDRIO FUME', ESPALDA Y COLUMNAS ENCHAPADO DE MADERA ACABADO ROVERE CARBONE.



DETTAGLIO MADIA  
CON ANTE IN  
FINITURA BLUNA  
TECH ALLUMINIO  
CHAMPAGNE E GOLA  
ELLE IN FINITURA  
NERO OPACO. FIANCHI  
IN FINITURA LEGNO  
ROVERE CARBONE.  
TOP IN FINITURA GRES  
EMPERADOR OPACO.

DETAIL OF SIDEBOARD  
WITH BLUNA TECH  
DOORS ALUMINUM  
CHAMPAGNE FINISH  
AND ELLE GROOVE IN  
MATT BLACK FINISH.  
SIDE PANELS IN WOOD  
ROVERE CARBONE  
FINISH. TOP IN MATT  
GRES EMPERADOR  
FINISH.

DETAIL BUFFET  
AVEC FAÇADES EN  
FINITION BLUNA  
TECH ALUMINIUM  
CHAMPAGNE ET GORGE  
ELLE EN FINITION NOIR  
MAT. COTES DE FINITION  
INTEGRES BOIS ROVERE  
CARBONE. PLAN DE  
TRAVAIL EN FINITION  
GRES EMPERADOR MAT.

DETALLE APARADOR CON  
PUERTAS DE ACABADO  
BLUNA TECH ALLUMINIO  
CHAMPAGNE Y GOLA  
ELLE EN ACABADO  
NEGRO MATE. COSTADOS  
ENCHAPADOS DE MADERA  
ACABADO ROVERE  
CARBONE. ENCIMERA  
EN GRES ACABADO  
EMPERADOR OPACO.

166

167



BLUNA TECH CHAMPAGNE

SCHEDA TECNICA DATA SHEET  
FICHE TECHNIQUE FICHA DE DATOS



BLUNA TECH  
ALLUMINIO  
CHAMPAGNE

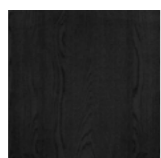

LEGNO ROVERE  
CARBONE

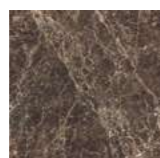

GRES EMPERADOR  
OPACO



LEGNO ROVERE  
GRIGIO LONDRA



BILAMINATO  
STRUTTURA NERO  
CARBONE



VETRO FUMÉ E  
ALLUMINIO NERO

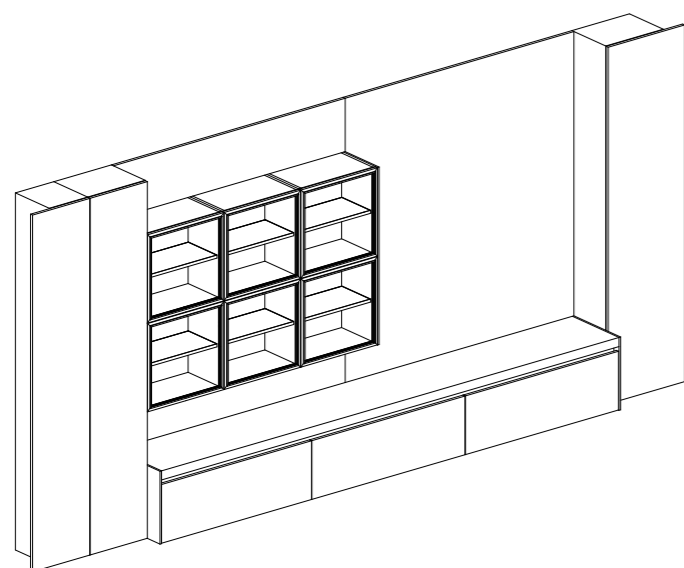

PARETE LIVING LIVING WALL

L 510 H 235,5 P 47,5/35,5

BLUNA TECH ALLUMINIO CHAMPAGNE  
BLUNA LEGNO ROVERE CARBONE  
VETRINE REFLEX TELAIO NERO OPACO E VETRO FUMÉ,  
STRUTTURA NERO CARBONE CON RIPIANI LUMINOSI  
SCHIENALE LEGNO ROVERE CARBONE  
TOP GRES EMPERADOR OPACO

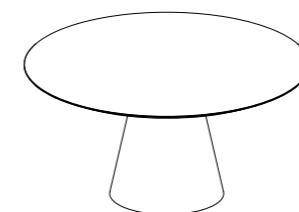

TAVOLO PISA TABLE

L. 150 H. 76 P. 150

TOP GRES EMPERADOR OPACO  
STRUTTURA LEGNO NOCE CANALETTO E SOTTOPIANA  
LACCATO OPACO TINTA NOCE

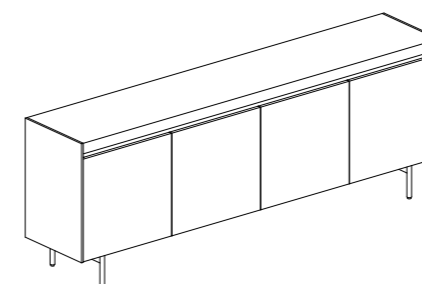

MADIA SIDEBOARD

L. 242,4 H. 89,5 P. 47,5

BLUNA TECH ALLUMINIO CHAMPAGNE  
TOP GRES EMPERADOR OPACO  
FIANCHI ESTERNI LEGNO ROVERE GRIGIO LONDRA  
BASAMENTO ROUND METALLO NERO OPACO

170

171

**FINITURE**

FINISHES

**TECH OPACO MATT TECH**



BIANCO NORDICO OPACO



GRIGIO PIETRA OPACO



CRETA OPACO



GRIGIO ARDESIA OPACO



VERDE POLVERE OPACO



BLU PROFONDO OPACO



NERO ONICE OPACO

**BLUNA**

172

**TECH ALLUMINIO ALUMINUM TECH**



ALLUMINIO CHAMPAGNE

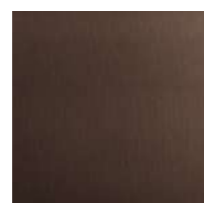

ALLUMINIO BRUNITO

**BLUNA**

**BILAMINATO LEGNO WOOD BILAMINATE**



ROVERE CHIARO

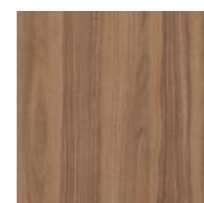

NOCE NATURALE



EUCALIPTO FUMO



NOCE CANTÙ

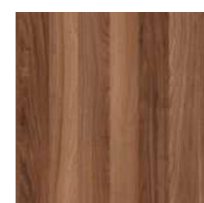

NOCE ADIGE



NOCE AMERICANO



NOCE MONZA



ROVERE LAVA



ROVERE QUERCIA

**BLUNA**

173

**BILAMINATO MATERICO TEXTURAL BILAMINATE**

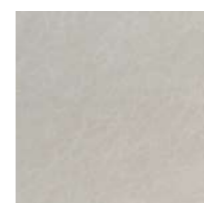

BETON ARGILLA



BETON GIOVE



PIETRA PIASENTINA



BETON SILVER



BETON NUVOLE

**BLUNA**

LACCATO OPACO/LUCIDO MATT/GLOSSY LACQUERED

BLUNA SCAVA VOGUE MANTIS



TITAN WHITE



BIANCO PURO

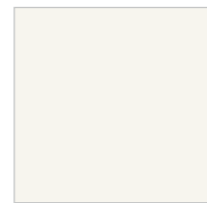

AVORIO

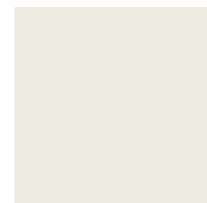

SAHARA BEIGE

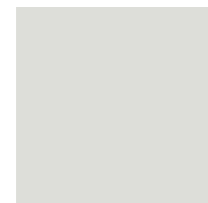

GRIGIO BOX



GRIGIO FUMO



BEIGE KENIA



CAPPUCCINO



COTONE



NOCCIOLA



GRIGIO FOSCO



GRIGIO LAVA



FERRO



CARRUBA



CAFFÈ



ROSSO TOSCA

174

175

LACCATO OPACO/LUCIDO MATT/GLOSSY LACQUERED

BLUNA SCAVA VOGUE MANTIS



ROSSO VINO



SALVIA



VERDE PASTELLO



VERDE BOSCO



BLU OCEANO



INK BLUE

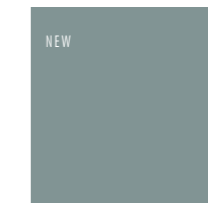

PAXOS GREY



GRIGIO ANTRACITE



NERO TRAFFICO



RAL



**LAMINATO FENIX FENIX LAMINATE**

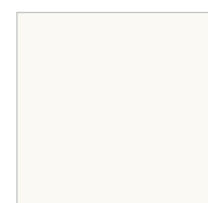

BIANCO KOS

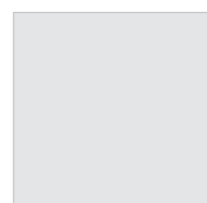

GRIGIO EFESO



CASTORO OTTAWA



GRIGIO LONDRA



VERDE COMODORO



ROSSO JAIPUR



GRIGIO BROMO



NERO INGO

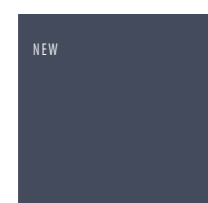

BLU FES



CACAO ORINOCO

**LEGNO WOOD**



ROVERE NATURALE  
PRECOMPOSTO ALPI

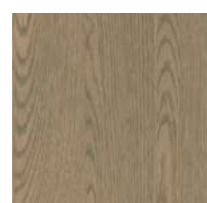

ROVERE MANHATTAN

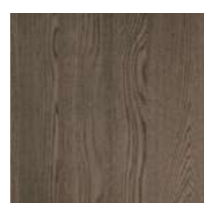

ROVERE GRIGIO PEPE

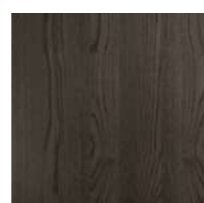

ROVERE GRIGIO LONDRA

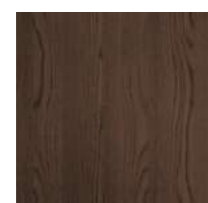

ROVERE TABACCO

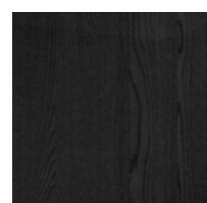

ROVERE CARBONE



ROVERE VESUVIO DOGA  
SFALSATA

**BLUNA WORKTOP**

176

177

**LEGNO SPECIALE A SPECIAL WOOD A**

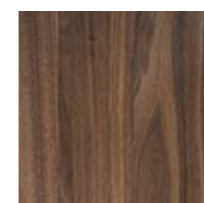

NOCE CANALETTO



ROVERE TERMOTRATTATO

**LEGNO SPECIALE B SPECIAL WOOD B**

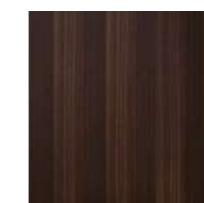

EUCALIPTO SCURO

**BLUNA SCAVA VOGUE AVOLA MANTIS**

**BLUNA SCAVA VOGUE AVOLA**

LACCATO METAL 4.0 4.0 METAL LACQUERED

BLUNA SCAVA VOGUE MANTIS



TITANIO

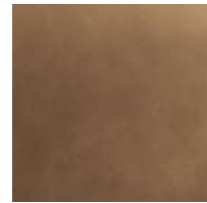

OTTONE

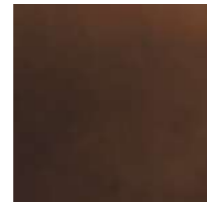

BRONZO

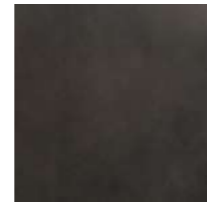

PELTRO

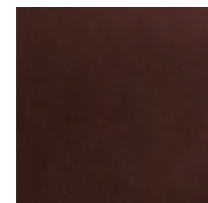

AMARANTO

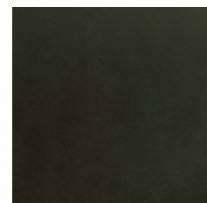

FORESTA



PIOMBO

178

179

LEGNO SPINA DI PESCE HERRINGBONE WOOD

MANTIS

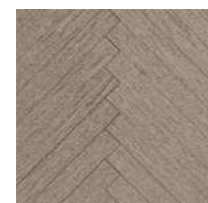

ROVERE SATURNO

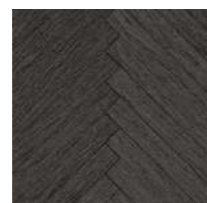

ROVERE CORTECCIA

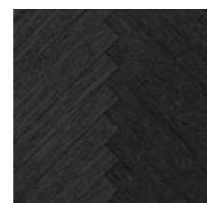

ROVERE MAGMA

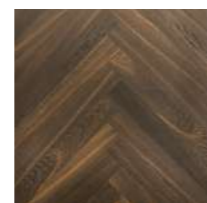

ROVERE TERMOTRATTATO

LEGNO RIGATO RIBBED WOOD

AVOLA

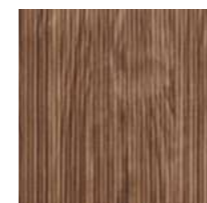

NOCE CANALETTO RIGATO

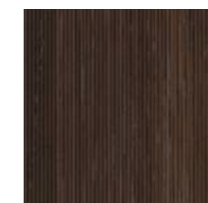

ROVERE TERMOTRATTATO RIGATO

VETRO GLASS



TITAN WHITE OPACO



GRIGIO BOX OPACO



BEIGE KENIA OPACO



GRIGIO ANTRACITE OPACO



NERO TRAFFICO OPACO



TITAN WHITE LUCIDO



GRIGIO BOX LUCIDO



BEIGE KENIA LUCIDO



GRIGIO ANTRACITE LUCIDO



NERO TRAFFICO LUCIDO



BRONZO OPACO



STOPSOL SPECCHIO BRONZO



STOPSOL SPECCHIO FUMÈ

LAB AVOLA

180

181

PIETRA NATURALE NATURAL STONE



BIANCO CARRARA SPAZZOLATO

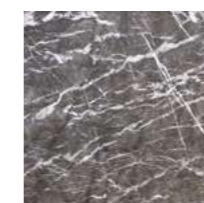

GRIGIO ALPINO SPAZZOLATO



ARABESCATO OROBICO LUCIDO



BROWN EMPERADOR LUCIDO

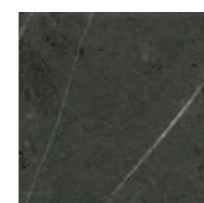

GREY STONE SPAZZOLATO



ROSSO LEVANTO LUCIDO



GRANITO NEW CAMBRIAN BLACK SPAZZOLATO

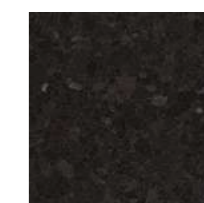

BROWN ANTIQUE SPAZZOLATO

WORKTOP

**GRES**

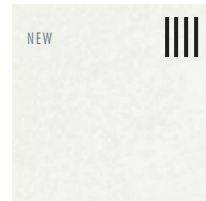

WHITE MAT



BASALTO MAT

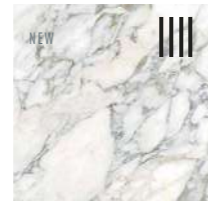

ARABESCATO ORO OPACO



MARMORINO ORO OPACO



MARQUINA MAT

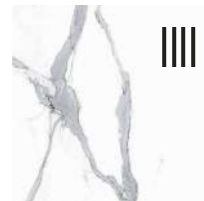

STATUARIO OPACO



STATUARIO LUCIDO

**GRES**



FOKOS SALE OPACO



FOKOS TERRA OPACO



FOKOS ROCCIA OPACO



FOKOS PIOMBO OPACO



CALCE TORTORA OPACO



CALCE NERO OPACO

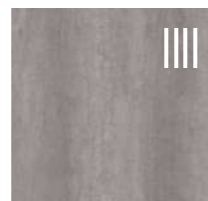

PIETRA DI SAVOIA GRIGIA BOCCIARDATA



PIETRA DI SAVOIA ANTRACITE BOCCIARDATA



EMPERADOR OPACO



INVISIBLE WHITE OPACO



PIETRA GREY OPACO

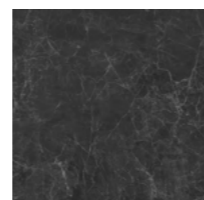

NERO GRECO OPACO

**Bi-Top**

AVOLA WORKTOP



MARMORINO ORO OPACO



STATUARIO OPACO

**LAMINAM**  
SUPERIOR NATURAL SURFACES

AVOLA WORKTOP



FOKOS PIOMBO OPACO



PIETRA DI SAVOIA ANTRACITE BOCCIARDATA

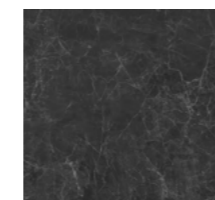

NERO GRECO OPACO

**GRES**



NOIR DESIR OPACO



VERDE ALPI LUCIDO



PIASENTINA GRIGIO FIAMMATO

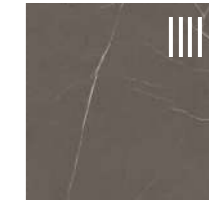

PIASENTINA TAUPE FIAMMATO

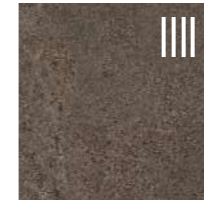

PORFIDO MARRONE FIAMMATO



TERRA DI MATERA OPACO



TERRA DI SATURNIA OPACO



TERRA DI POMPEI OPACO



CARDOSO NERO FIAMMATO

**GRES**



CALACATTA GOLD NAT



CALACATTA GOLD LUCIDO



PAONAZZO BIONDO SILK



OROBICO DARK LUCIDO



TAJ MAHAL SILK

**LAMINAM**  
SUPERIOR NATURAL SURFACES

AVOLA WORKTOP

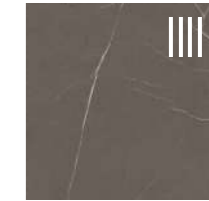

PIASENTINA TAUPE FIAMMATO



TERRA DI POMPEI OPACO

**X-TONE**

AVOLA WORKTOP



OROBICO DARK LUCIDO

## ART DIRECTION

MAMA STUDIO

## PRODUCT DESIGN

MAMA STUDIO

## GRAPHIC DESIGN

MAMA STUDIO

## COPY

MAMA STUDIO

## RENDER

MATIC ANIMATION

## COLOR SEPARATION

SINCROMIA

## PRINT

SINCROMIA



The mark of  
responsible forestry  
FSC® C136814



Prodotti certificati FSC®  
disponibili su richiesta

# Binova

è un marchio Cubo Design S.r.l.

Località Case Sciarroni - Grasciano  
I-64024 Notaresco - Teramo (TE) - Italy  
info@cubodesign.it  
www.binova.it

Cubo design S.r.l. nel perseguire una politica volta al costante miglioramento, si riserva il diritto di apportare, in qualsiasi momento e senza preavviso, le modifiche ai prodotti che riterrà utili e necessarie. L'effettiva disponibilità di quanto a catalogo deve essere verificata al momento dell'ordine. A causa di naturali limiti tecnici di riproduzione e stampa, il colore dei modelli a catalogo è puramente indicativo e non può costituire motivo di rivalsa. Cubo design S.r.l. declina ogni responsabilità per difetti e malfunzionamenti di elettrodomestici ed apparecchiature: eventuali contestazioni dovranno essere rivolte direttamente al produttore ed ai loro centri di assistenza. In order to constantly improve its products, Cubo design S.r.l. reserves the right to modify its products as it sees fit, without prior notification. The effective availability of the articles in the catalogue, must be actually checked out at the time of the order. Because of natural technical limits of the method of reproduction and printing, the colour of the models in the catalogue is purely indicative and cannot be claimed as reason for compensation and legal action. Cubo design S.r.l. every liability for defects and malfunctioning of appliances and pieces of equipment: eventual claims will have to be addressed directly to the producers and their assistance centres.